

6.4 MAXIMUM FLOW



- ▶ overview
- ▶ Ford-Fulkerson algorithm
- ▶ analysis
- ▶ Java implementation
- ▶ applications

- ▶ **overview**

- ▶ Ford-Fulkerson algorithm

- ▶ analysis

- ▶ Java implementation

- ▶ applications

Mincut problem

Input. A weighted digraph, source vertex s , and target vertex t .

each edge has a positive capacity

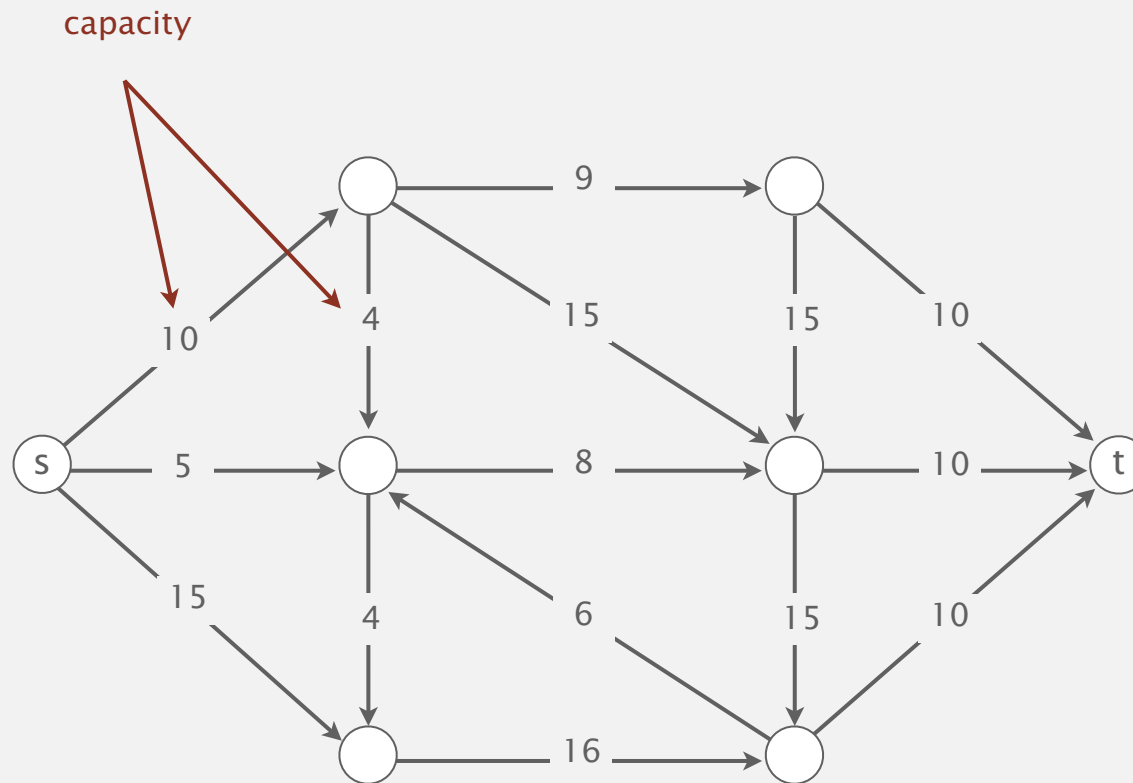

Mincut problem

Def. A *st-cut (cut)* is a partition of the vertices into two disjoint sets, with s in one set A and t in the other set B .

Def. Its *capacity* is the sum of the capacities of the edges from A to B .

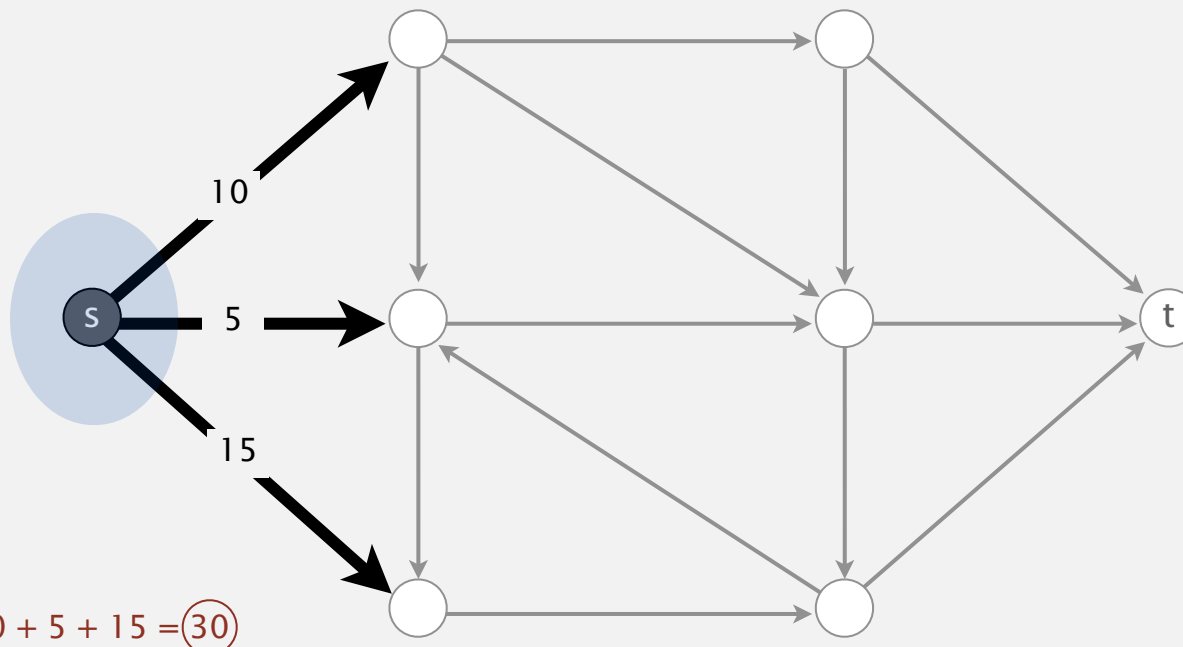

Mincut problem

Def. A *st-cut* (*cut*) is a partition of the vertices into two disjoint sets, with s in one set A and t in the other set B .

Def. Its *capacity* is the sum of the capacities of the edges from A to B .

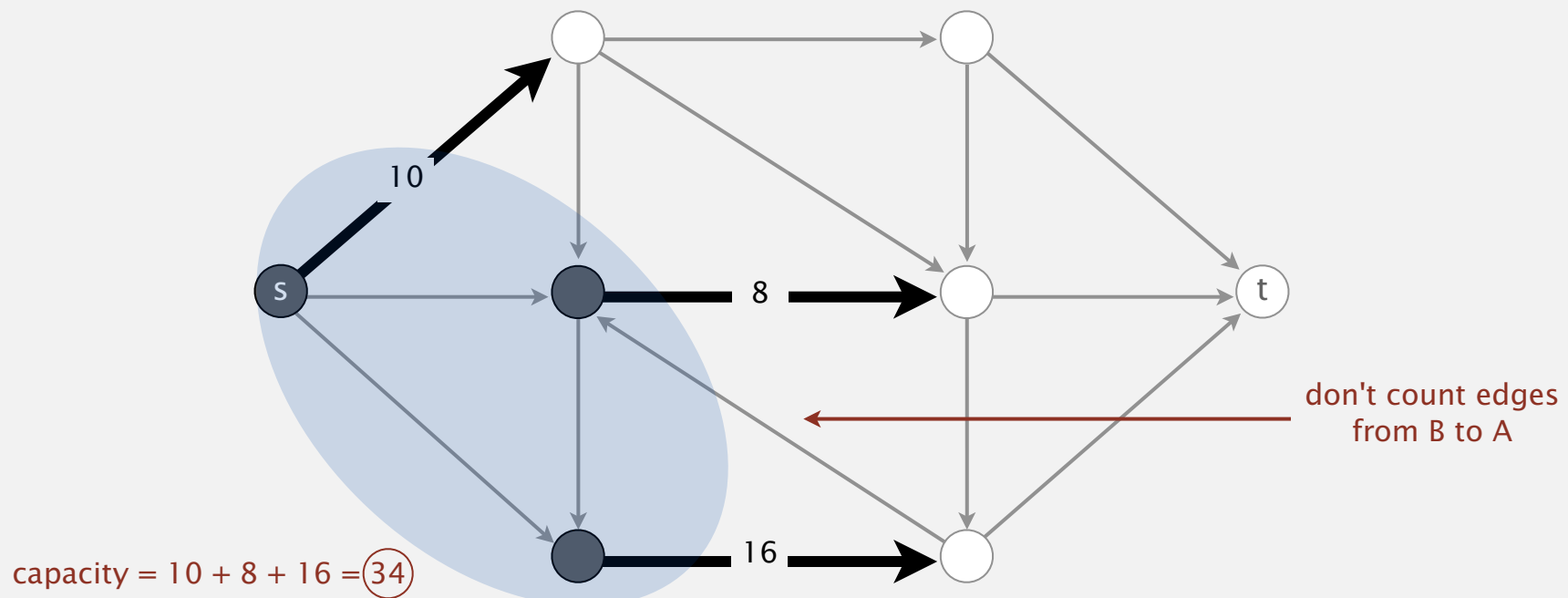

Mincut problem

Def. A *st-cut (cut)* is a partition of the vertices into two disjoint sets, with s in one set A and t in the other set B .

Def. Its *capacity* is the sum of the capacities of the edges from A to B .

Minimum st-cut (mincut) problem. Find a cut of minimum capacity.

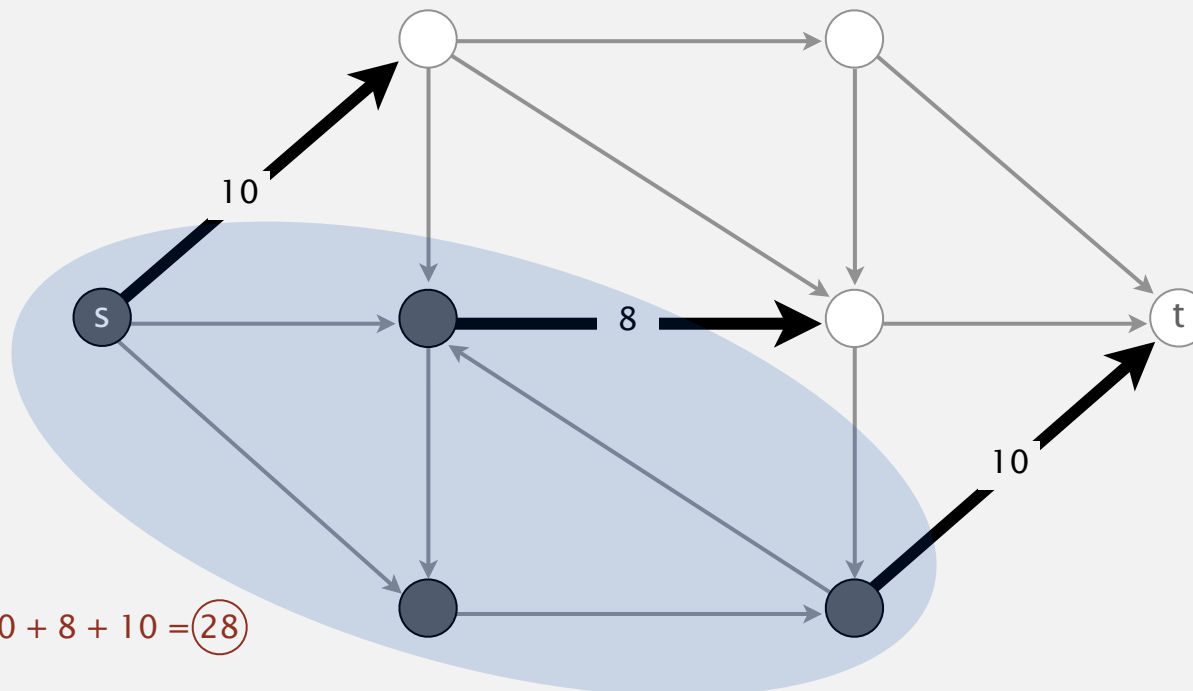

Mincut application (1950s)

"Free world" goal. Cut supplies (if cold war turns into real war).

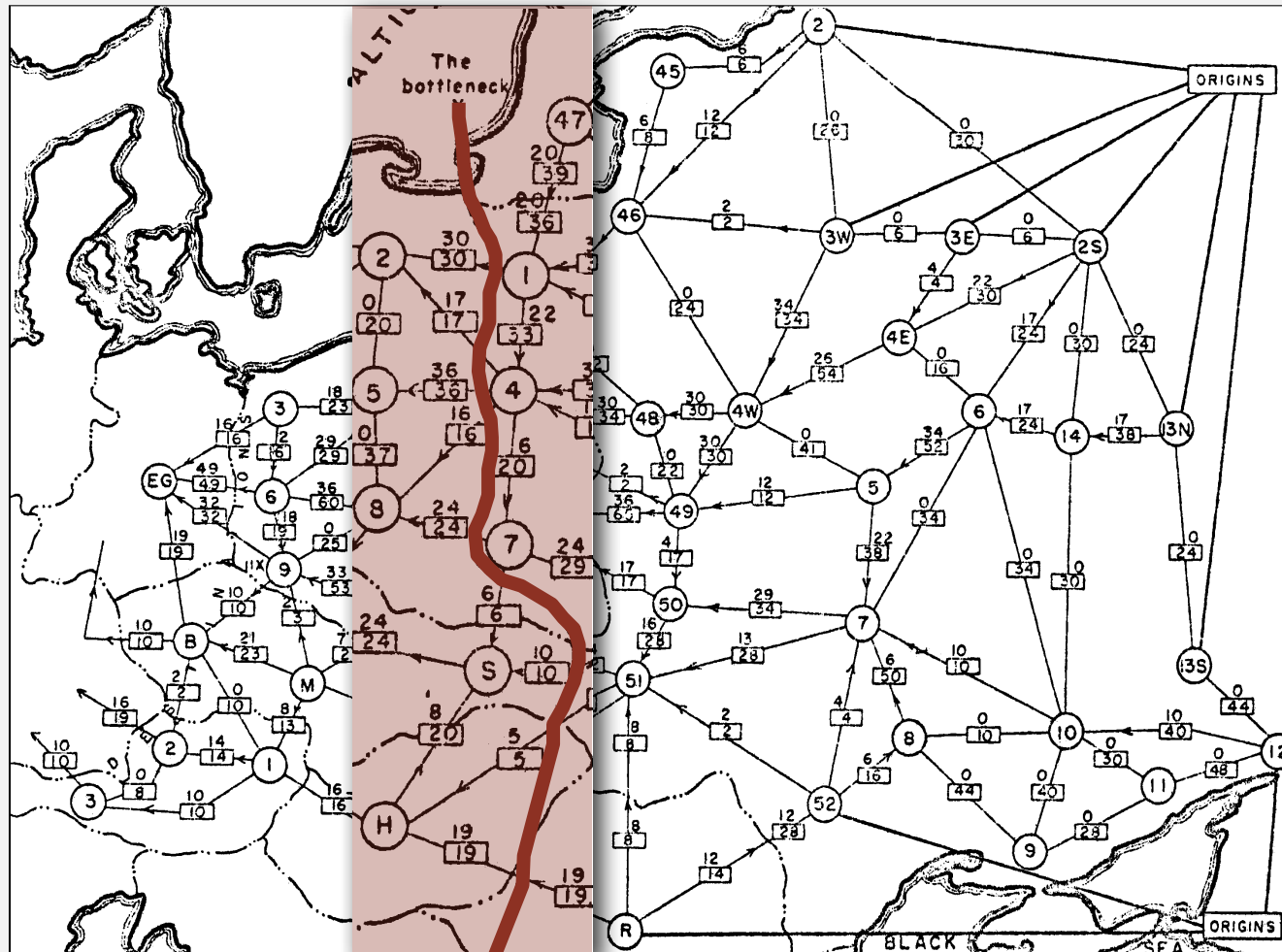

rail network connecting Soviet Union with Eastern European countries
(map declassified by Pentagon in 1999)

Potential mincut application (2010s)

Government-in-power's goal. Cut off communication to specified set of people.



Maxflow problem

Input. A weighted digraph, source vertex s , and target vertex t .

each edge has a
positive capacity

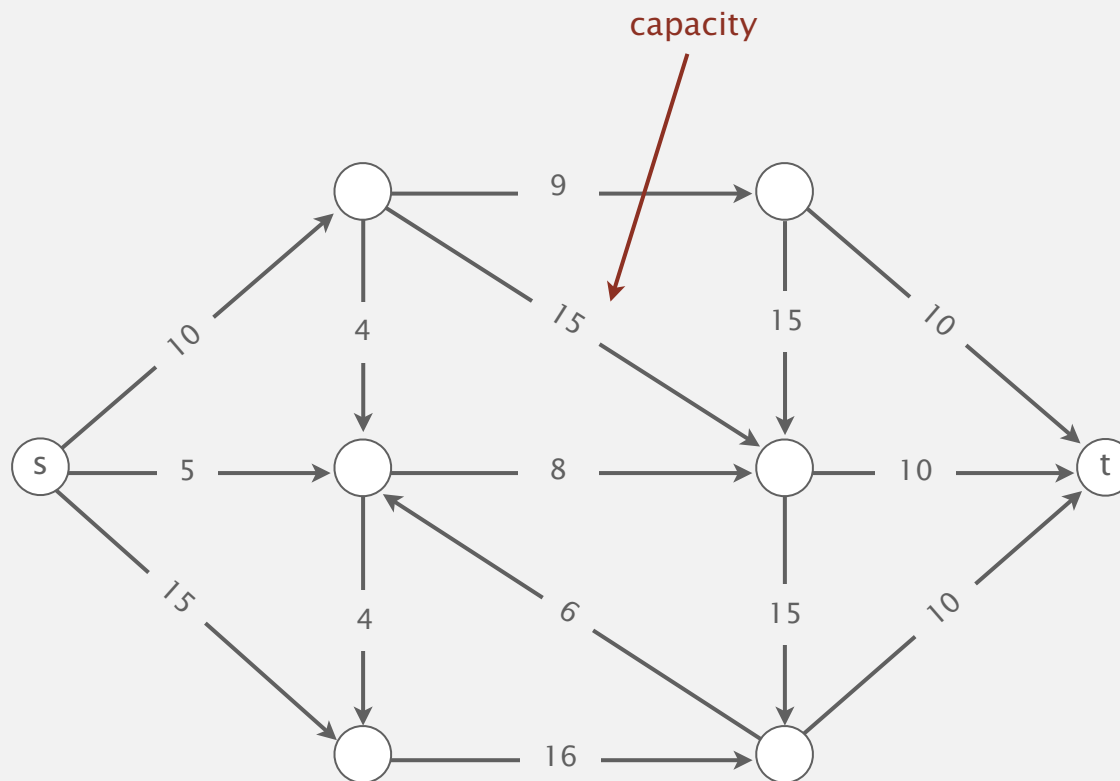

Maxflow problem

Def. An *st-flow* (flow) is an assignment of values to the edges such that:

- Capacity constraint: $0 \leq \text{edge's flow} \leq \text{edge's capacity}$.
- Local equilibrium: inflow = outflow at every vertex (except s and t).

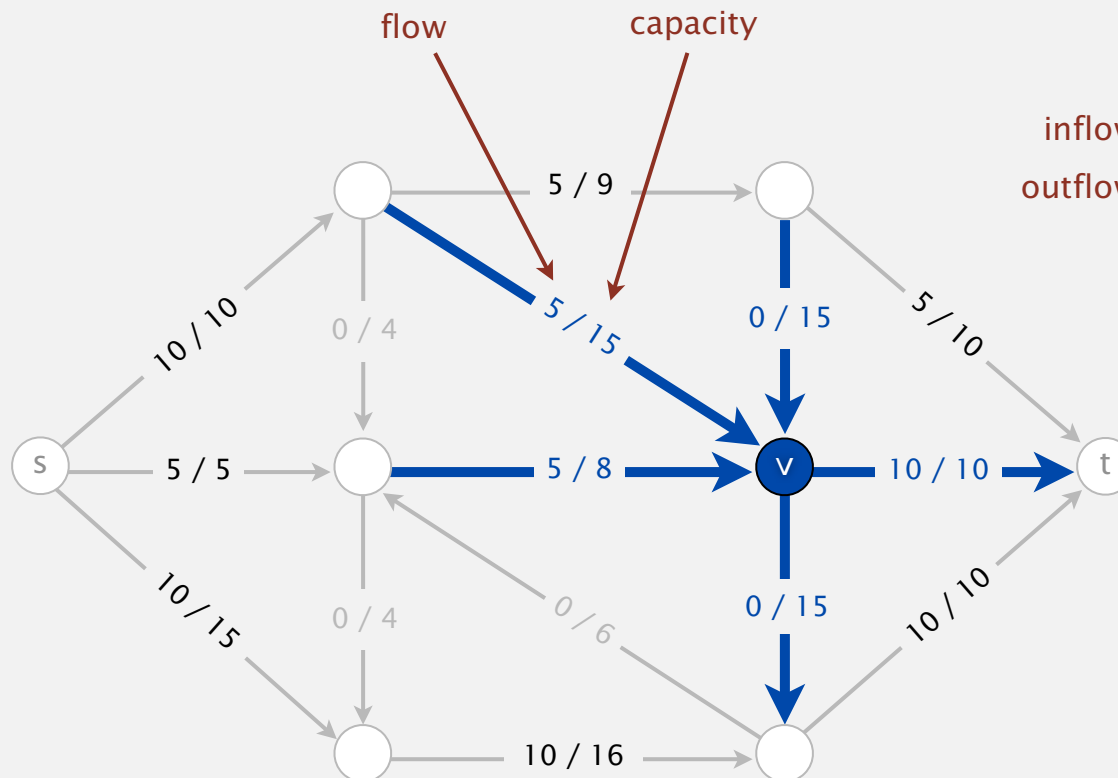

Maxflow problem

Def. An *st*-flow (flow) is an assignment of values to the edges such that:

- Capacity constraint: $0 \leq \text{edge's flow} \leq \text{edge's capacity}$.
- Local equilibrium: inflow = outflow at every vertex (except *s* and *t*).

Def. The *value* of a flow is the inflow at *t*.

we assume no edge points from *s* or to *t*

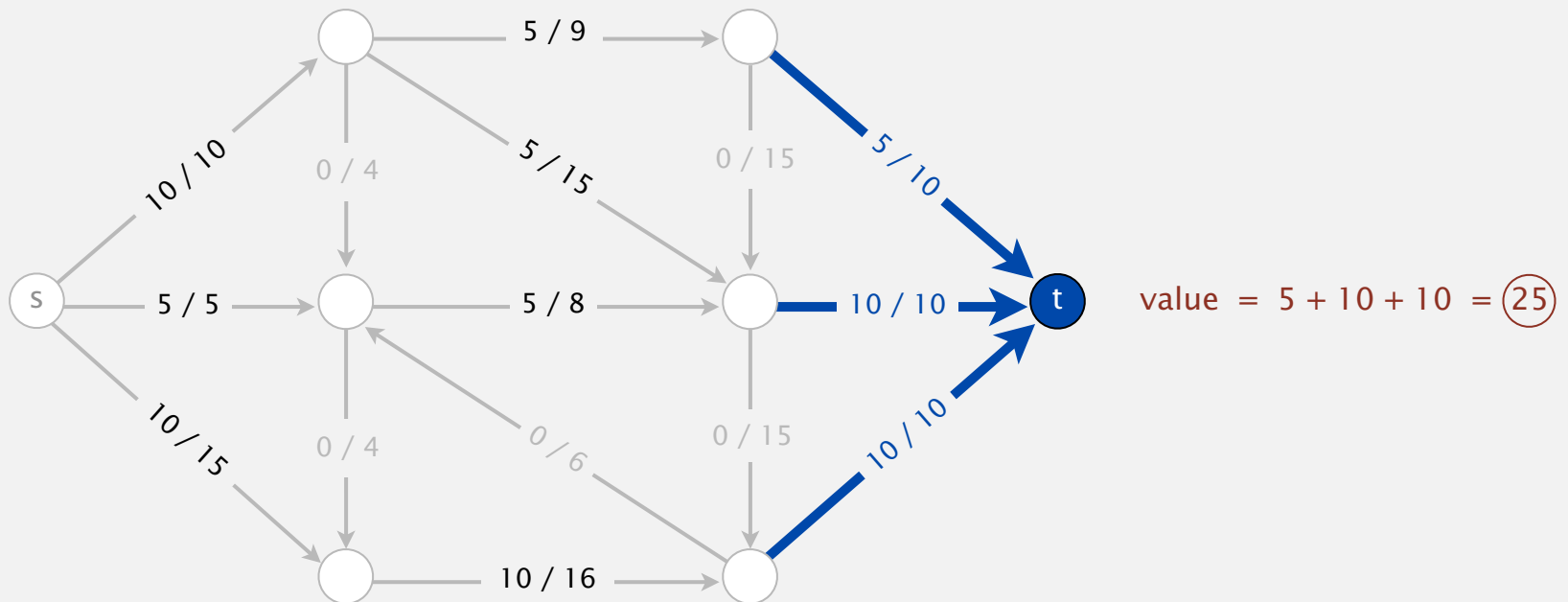

Maxflow problem

Def. An *st-flow* (flow) is an assignment of values to the edges such that:

- Capacity constraint: $0 \leq \text{edge's flow} \leq \text{edge's capacity}$.
- Local equilibrium: inflow = outflow at every vertex (except s and t).

Def. The *value* of a flow is the inflow at t .

Maximum *st-flow* (maxflow) problem. Find a flow of maximum value.

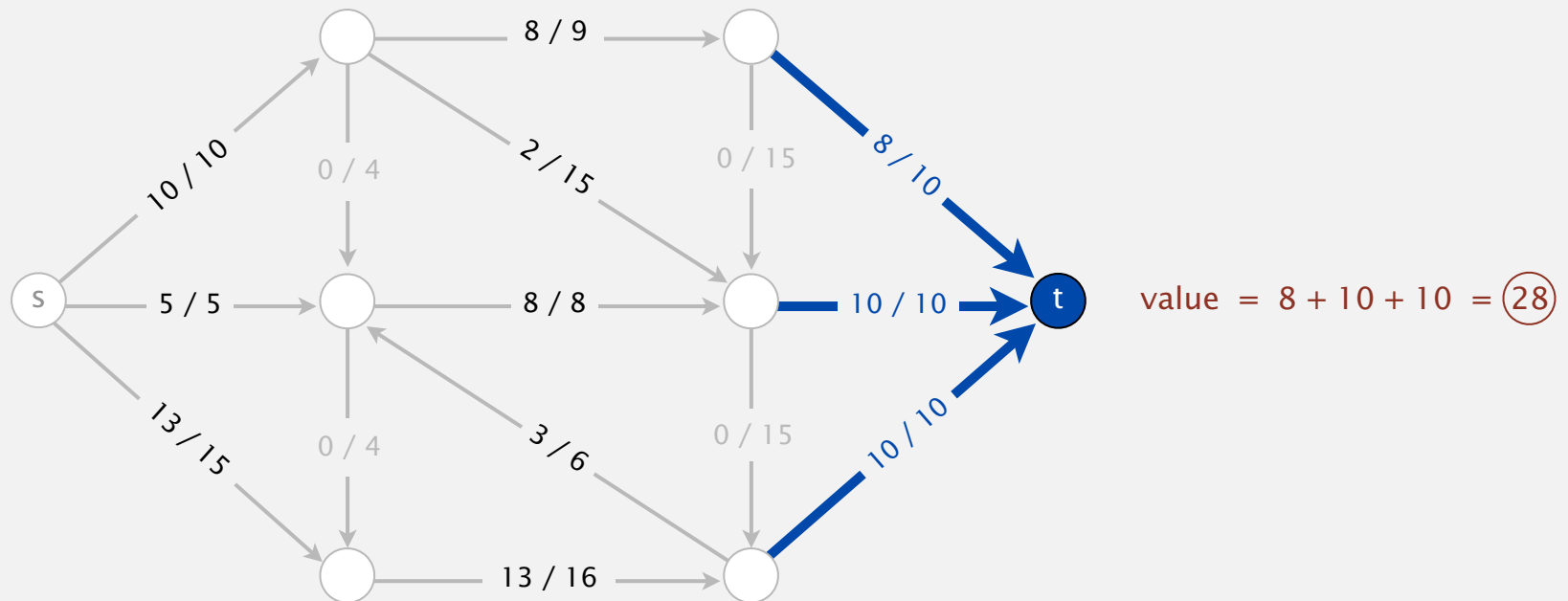

Maxflow application (1950s)

Soviet Union goal. Maximize flow of supplies to Eastern Europe.

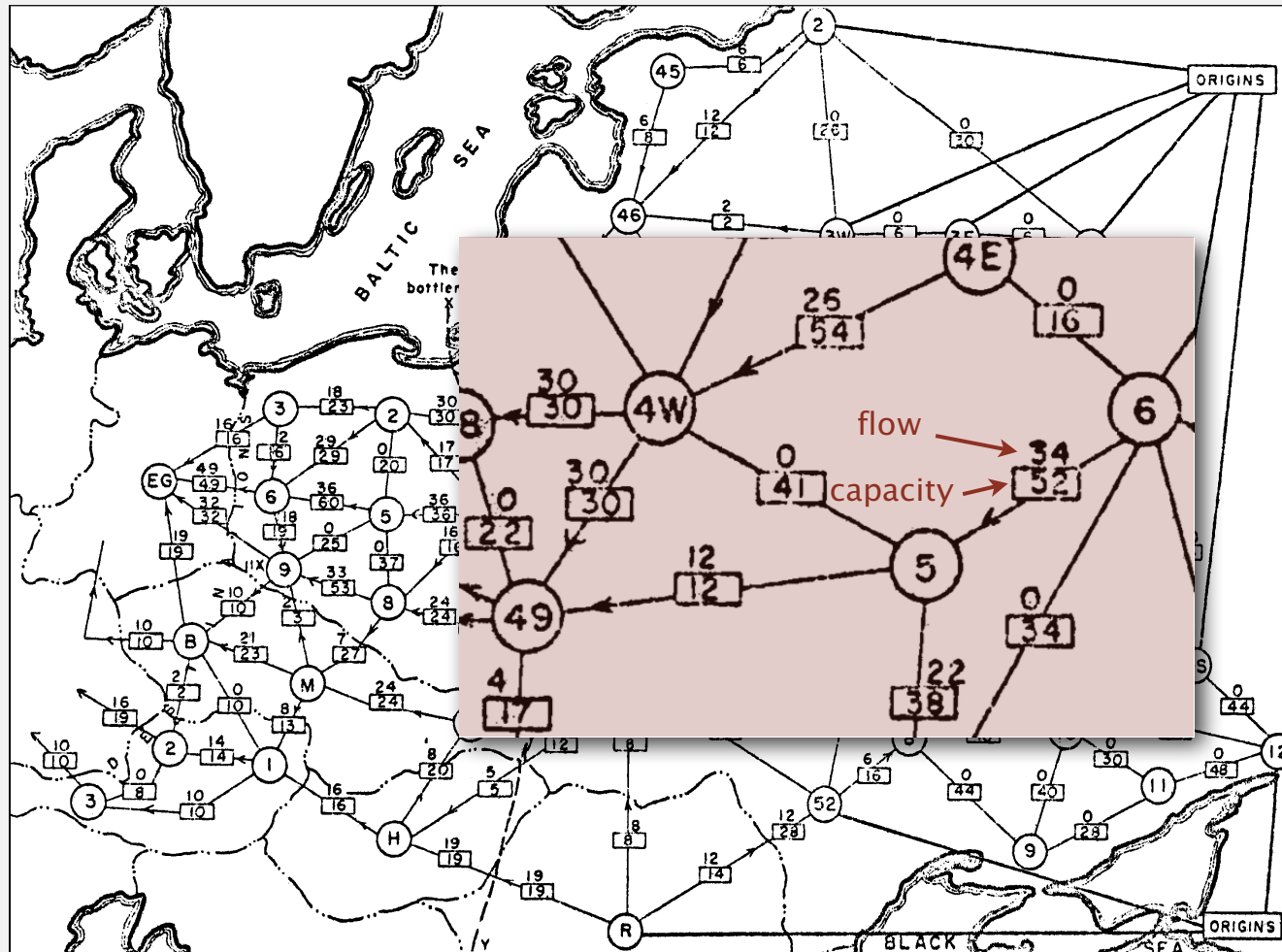

rail network connecting Soviet Union with Eastern European countries
(map declassified by Pentagon in 1999)

Potential maxflow application (2010s)

"Free world" goal. Maximize flow of information to specified set of people.



facebook graph

Summary

Input. A weighted digraph, source vertex s , and target vertex t .

Mincut problem. Find a cut of minimum capacity.

Maxflow problem. Find a flow of maximum value.

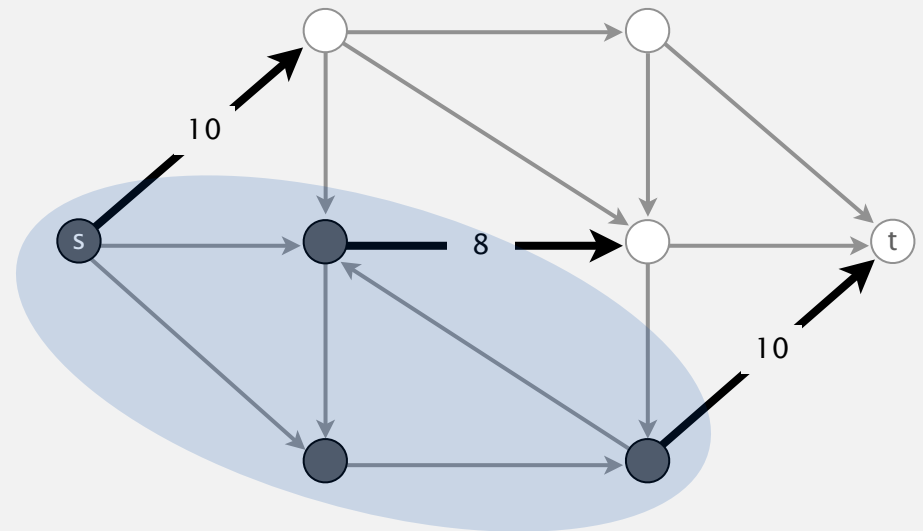
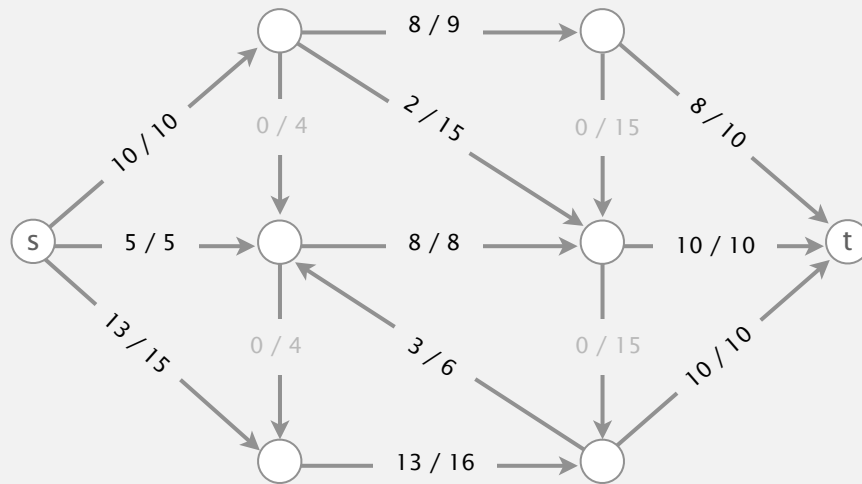

Remarkable fact. These two problems are dual!

- ▶ overview
- ▶ **Ford-Fulkerson algorithm**
- ▶ analysis
- ▶ Java implementation
- ▶ applications

Ford-Fulkerson algorithm

Initialization. Start with 0 flow.

initialization

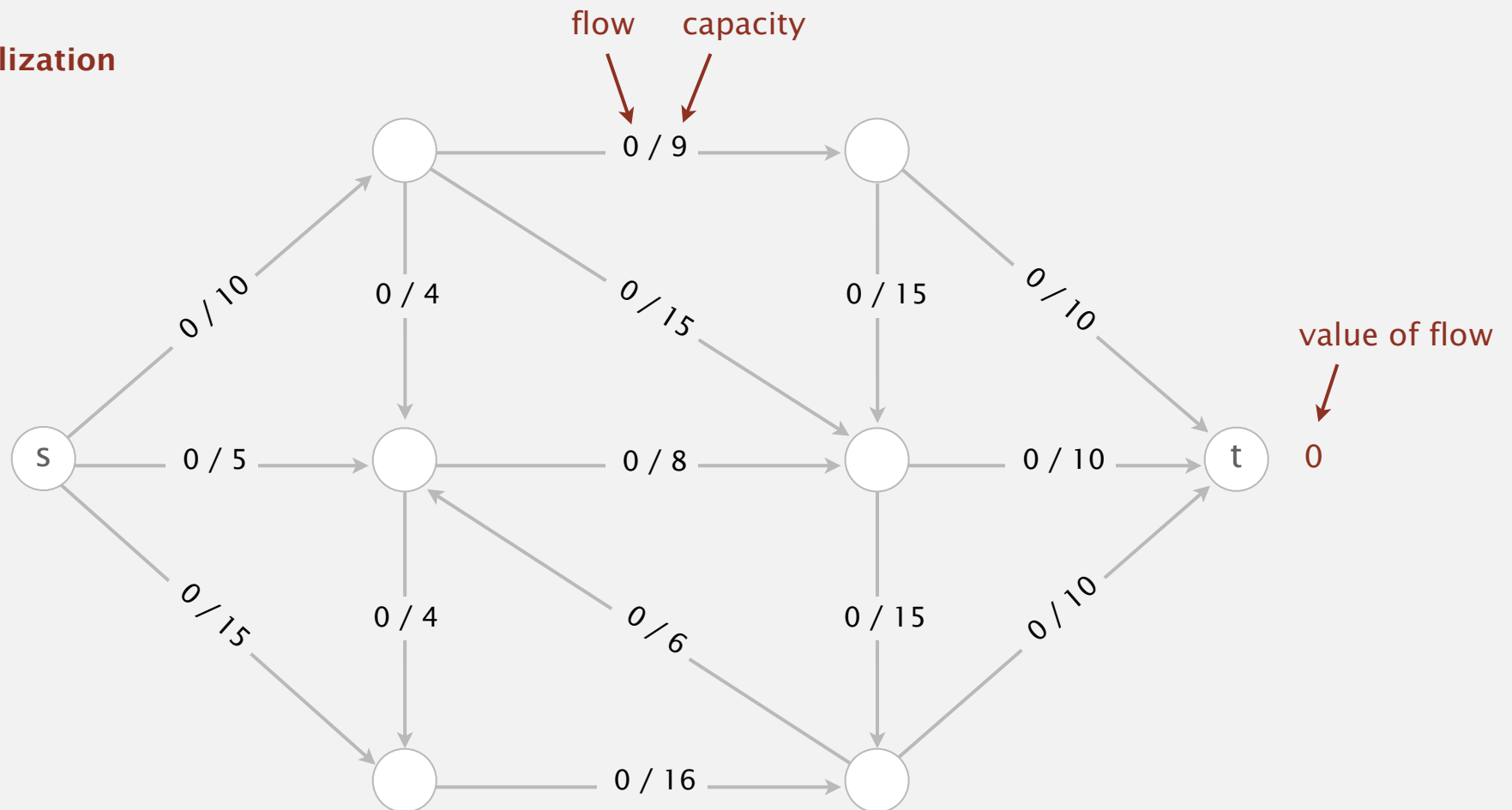

Idea: increase flow along augmenting paths

Augmenting path. Find an undirected path from s to t such that:

- Can increase flow on forward edges (not full).
- Can decrease flow on backward edge (not empty).

1st augmenting path

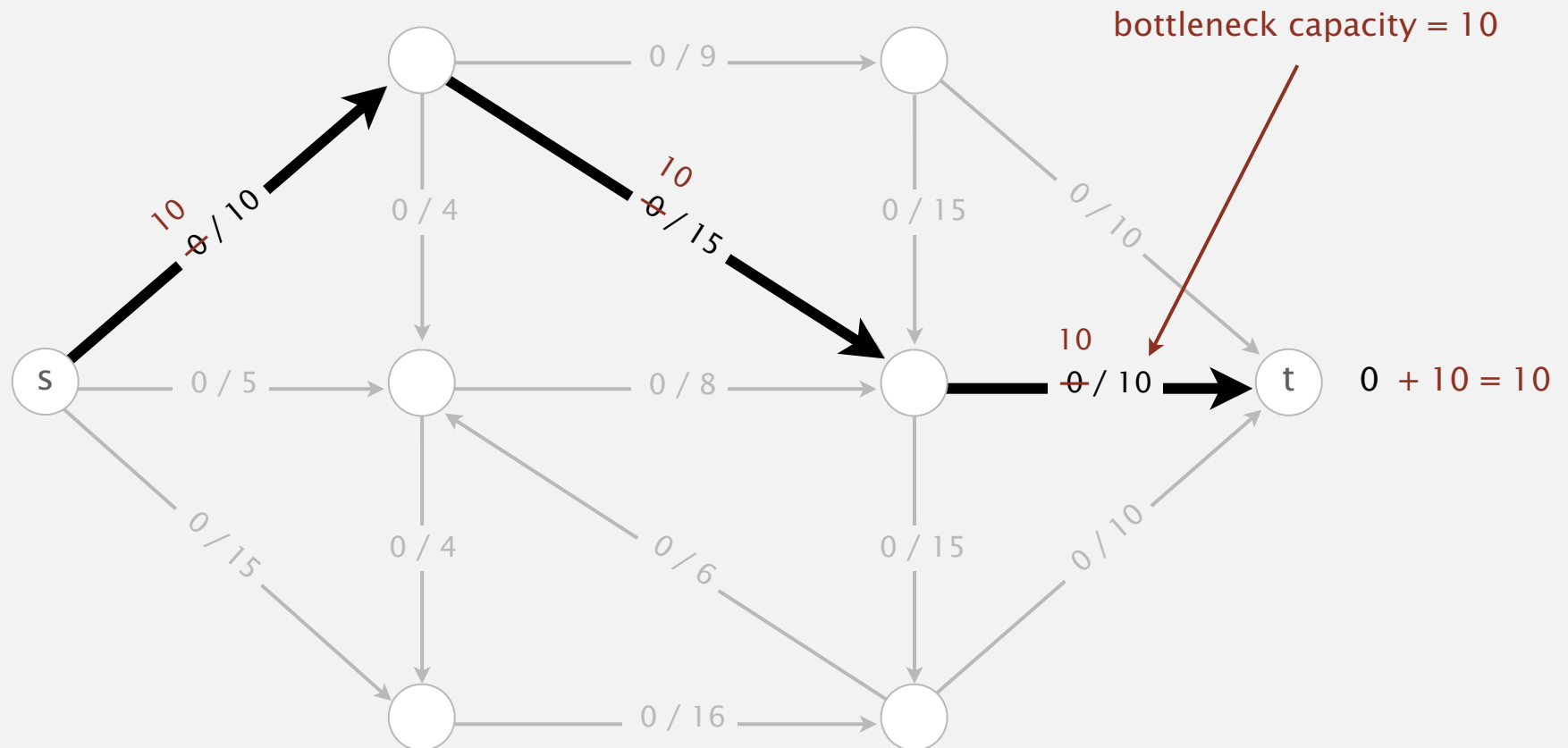

Idea: increase flow along augmenting paths

Augmenting path. Find an undirected path from s to t such that:

- Can increase flow on forward edges (not full).
- Can decrease flow on backward edge (not empty).

2nd augmenting path

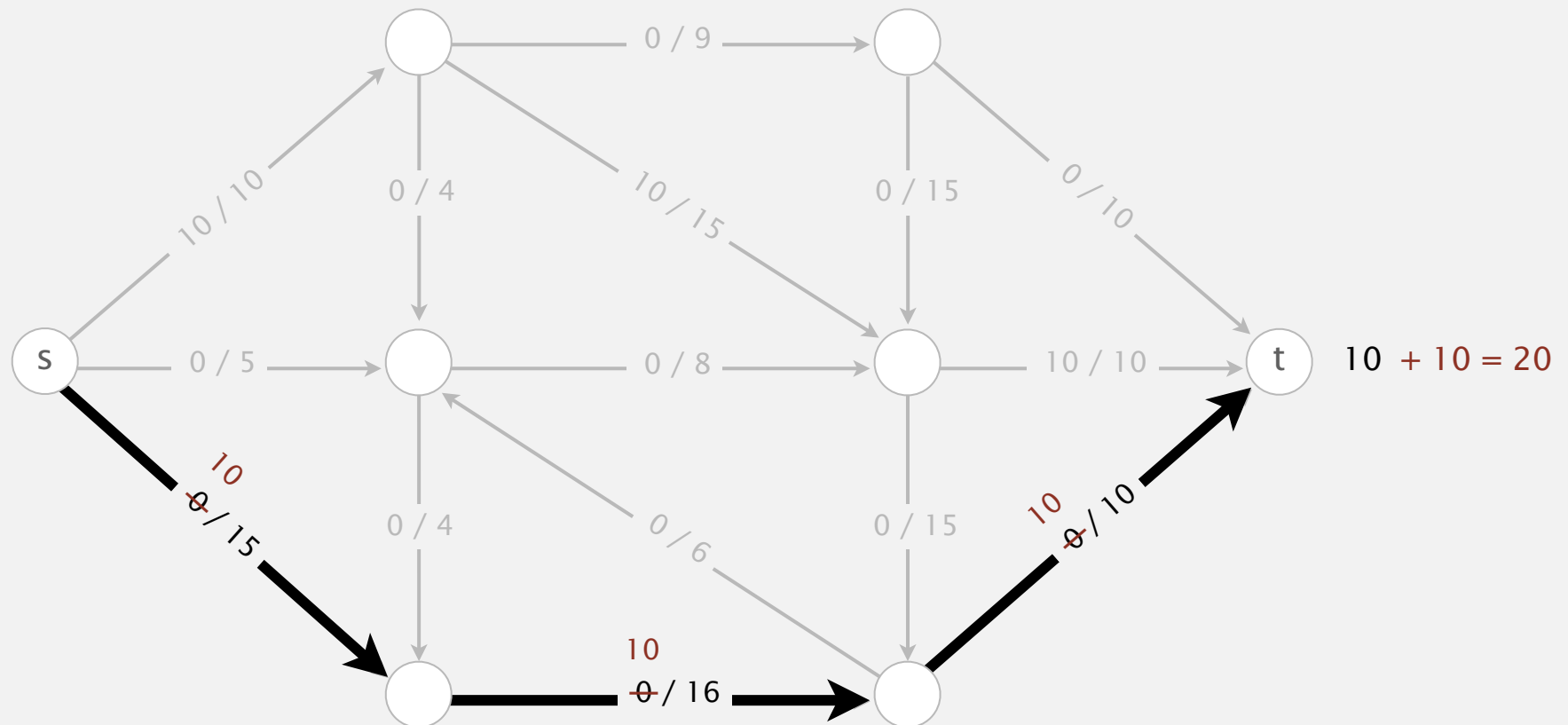

Idea: increase flow along augmenting paths

Augmenting path. Find an undirected path from s to t such that:

- Can increase flow on forward edges (not full).
- Can decrease flow on backward edge (not empty).

3rd augmenting path

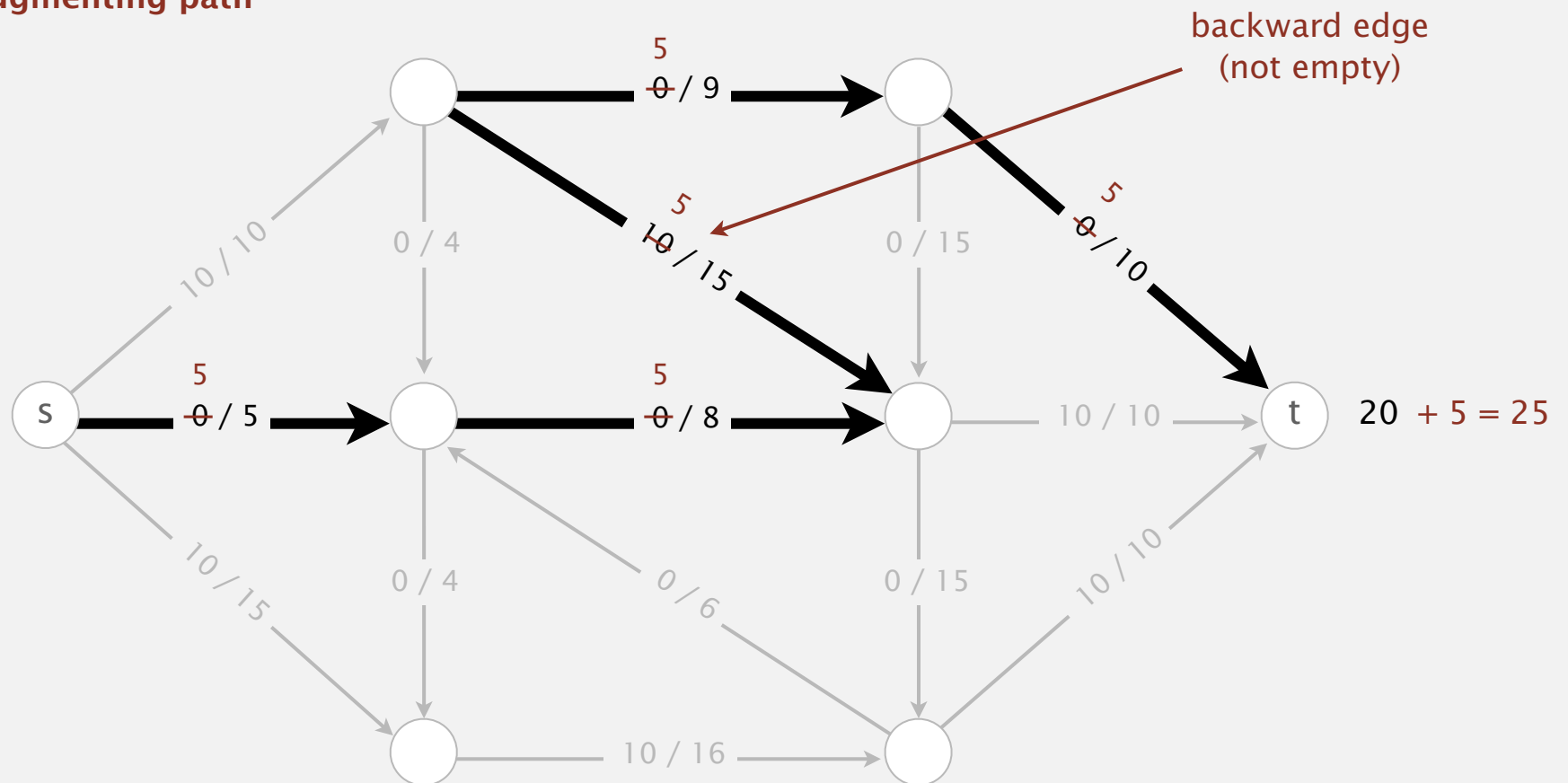

Idea: increase flow along augmenting paths

Augmenting path. Find an undirected path from s to t such that:

- Can increase flow on forward edges (not full).
- Can decrease flow on backward edge (not empty).

4th augmenting path

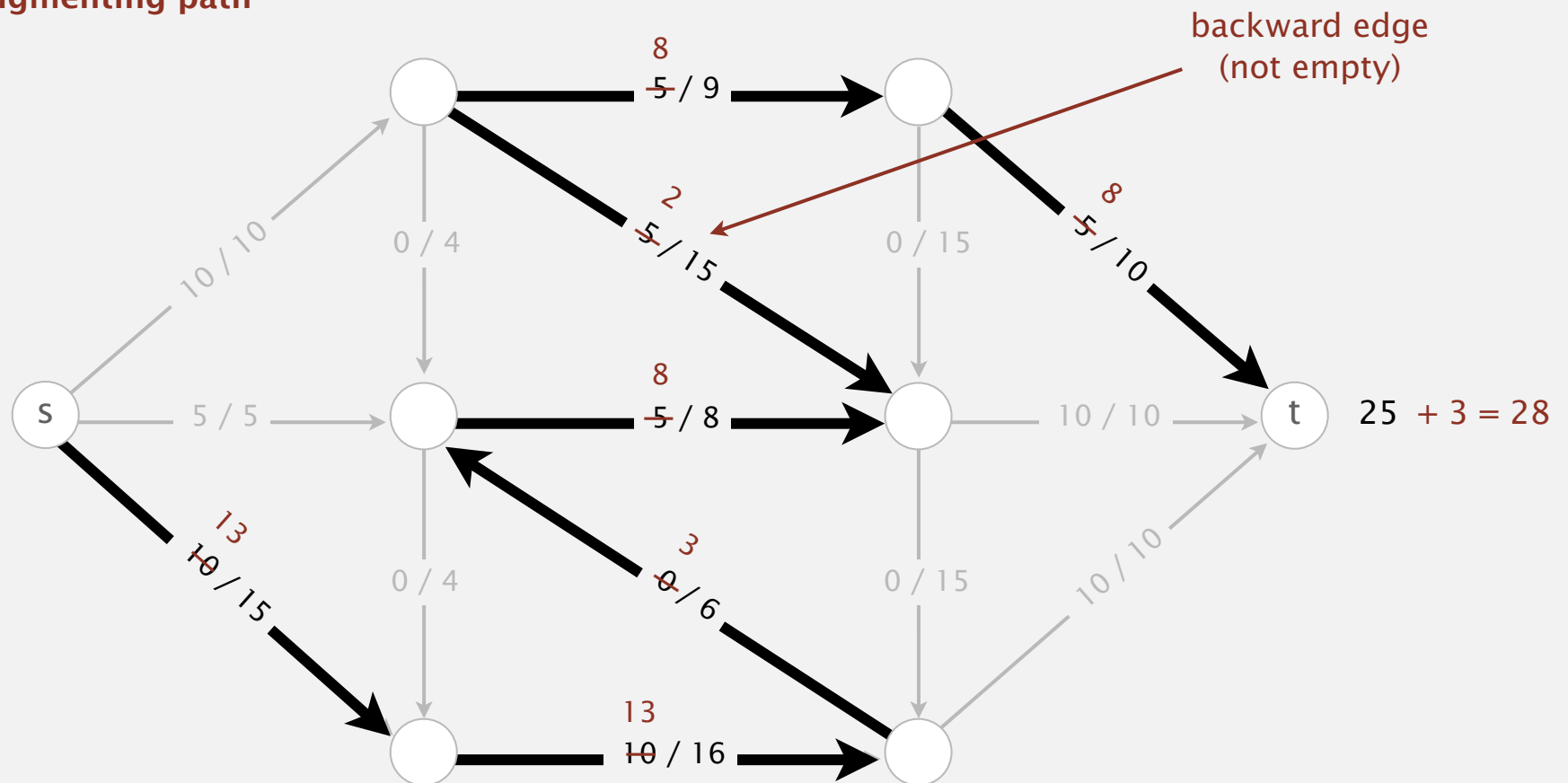

Idea: increase flow along augmenting paths

Termination. All paths from s to t are blocked by either a

- Full forward edge.
- Empty backward edge.

no more augmenting paths

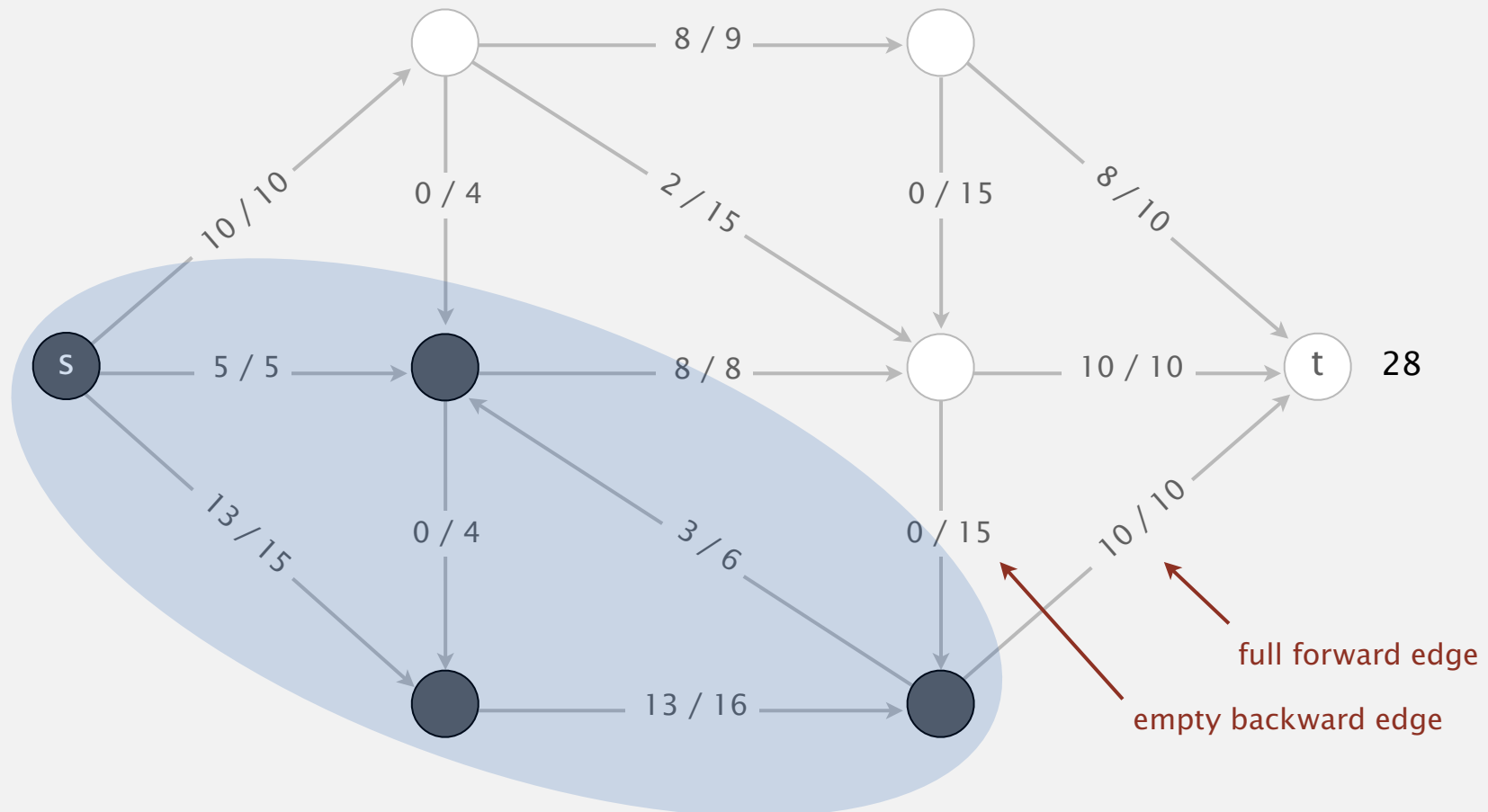

Ford-Fulkerson algorithm

Ford-Fulkerson algorithm

Start with 0 flow.

While there exists an augmenting path:

- find an augmenting path
 - compute bottleneck capacity
 - increase flow on that path by bottleneck capacity
-

Questions.

- How to compute a mincut?
- How to find an augmenting path?
- If FF terminates, does it always compute a maxflow?
- Does FF always terminate? If so, after how many augmentations?

- ▶ overview
- ▶ Ford-Fulkerson algorithm
- ▶ **analysis**
- ▶ Java implementation
- ▶ applications

Relationship between flows and cuts

Def. The **net flow across** a cut (A, B) is the sum of the flows on its edges from A to B minus the sum of the flows on its edges from B to A .

Proposition. Let f be any flow and let (A, B) be any cut. Then, the net flow across (A, B) equals the value of f .

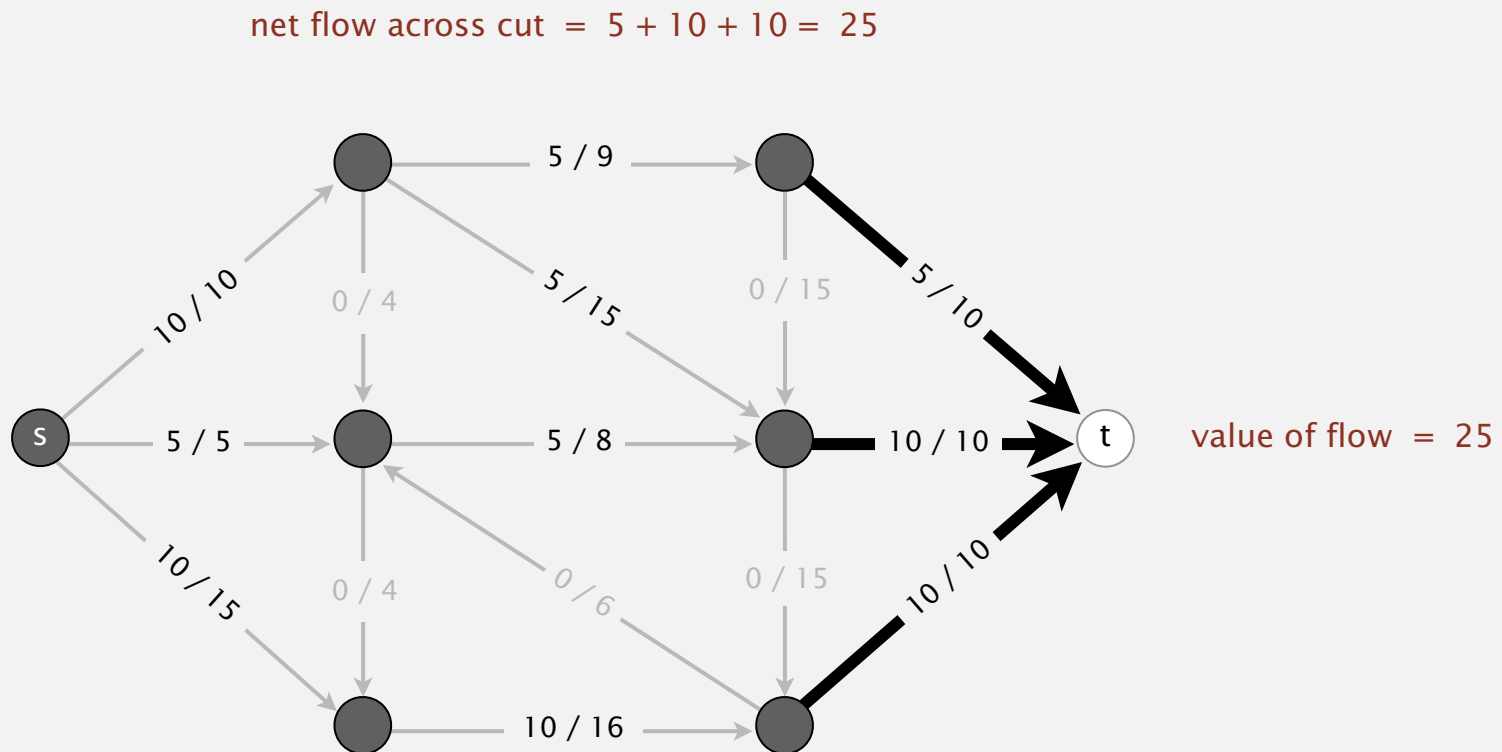

Relationship between flows and cuts

Def. The **net flow across** a cut (A, B) is the sum of the flows on its edges from A to B minus the sum of the flows on its edges from B to A .

Proposition. Let f be any flow and let (A, B) be any cut. Then, the net flow across (A, B) equals the value of f .

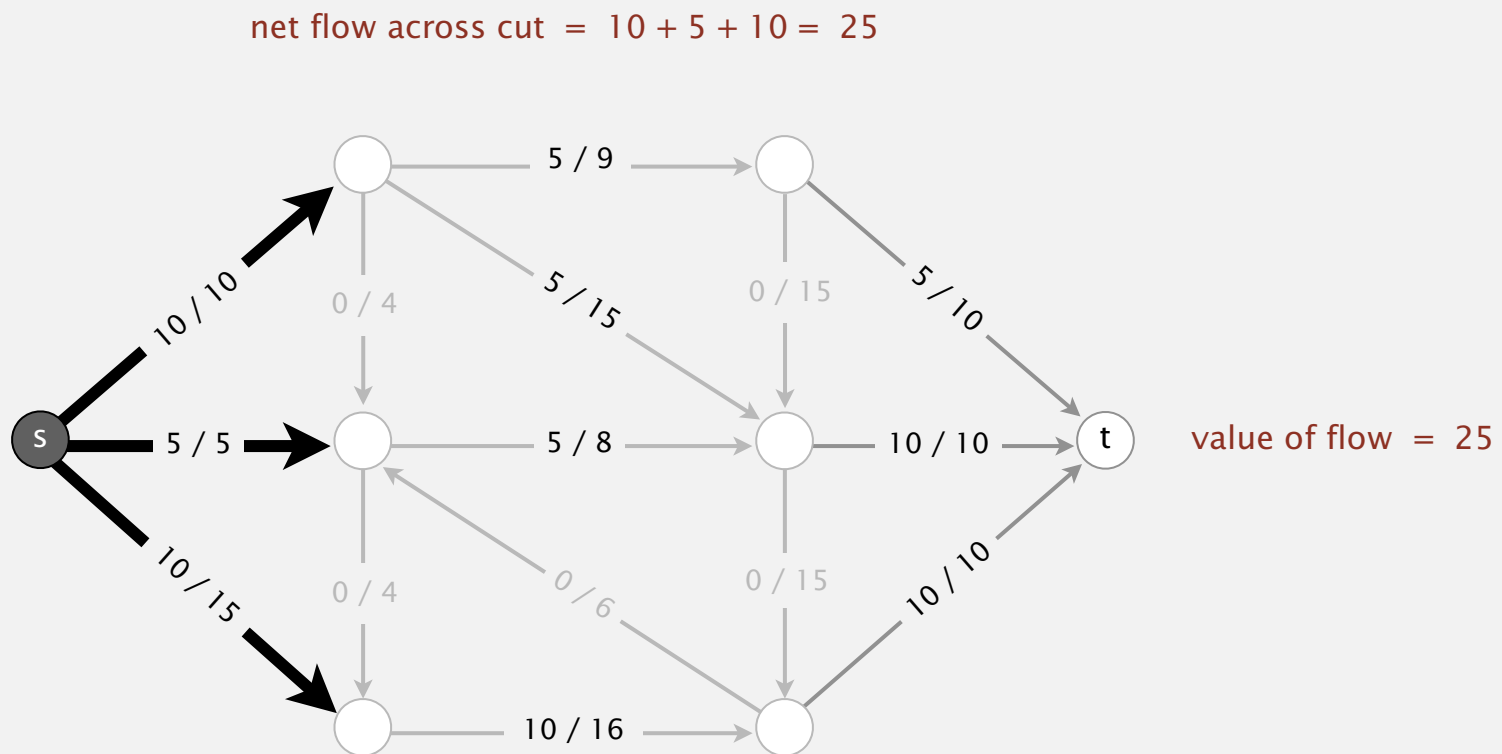

Relationship between flows and cuts

Def. The **net flow across** a cut (A, B) is the sum of the flows on its edges from A to B minus the sum of the flows on its edges from B to A .

Proposition. [flow-value lemma] Let f be any flow and let (A, B) be any cut. Then, the net flow across (A, B) equals the value of f .

$$\text{net flow across cut} = (10 + 10 + 5 + 10) - (5 + 5) = 25$$

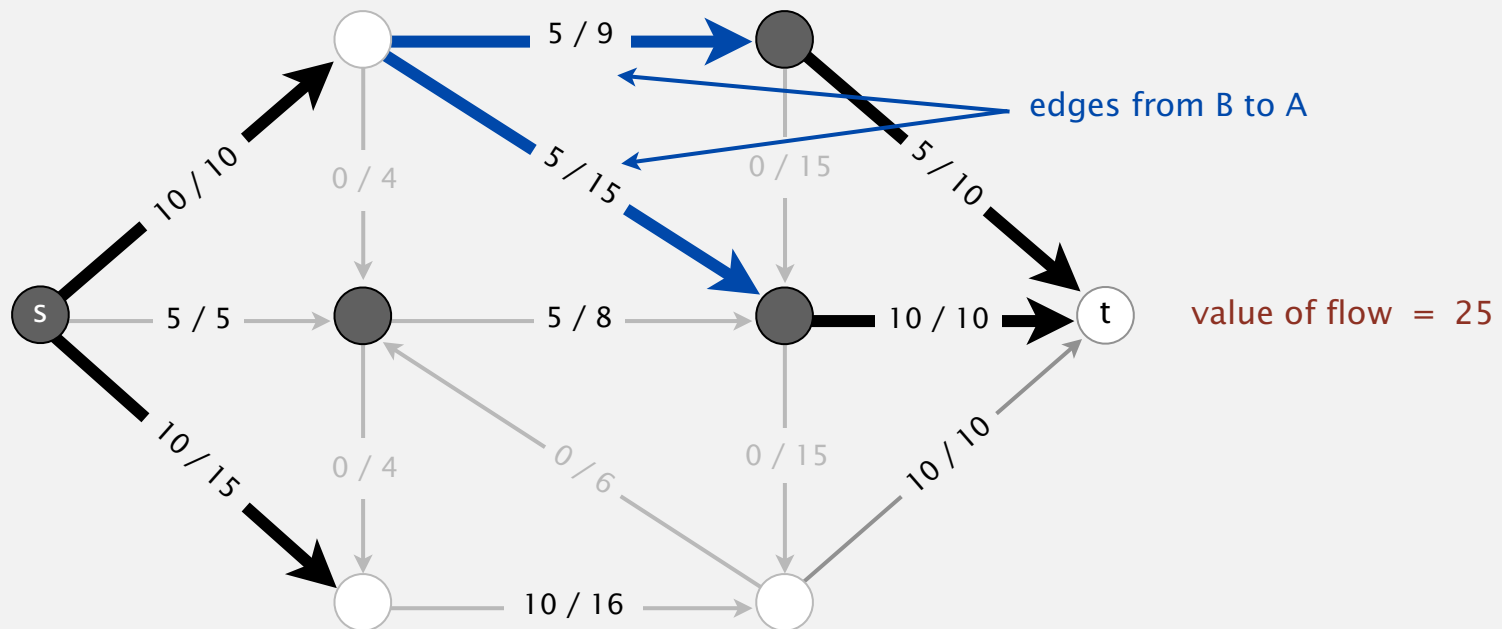

Relationship between flows and cuts

Def. The **net flow across** a cut (A, B) is the sum of the flows on its edges from A to B minus the sum of the flows on its edges from B to A .

Proposition. [flow-value lemma] Let f be any flow and let (A, B) be any cut. Then, the net flow across (A, B) equals the value of f .

Pf. By induction on the size of B .

- Base case: $B = \{t\}$.
- Induction step: remains true by local equilibrium when moving any vertex from A to B .

Corollary. Outflow from s = inflow to t = value of flow.

Relationship between flows and cuts

Weak duality. Let f be any flow and let (A, B) be any cut. Then, the value of the flow \leq the capacity of the cut.

Pf. Value of flow f = net flow across cut $(A, B) \leq$ capacity of cut (A, B) .

↑
flow value lemma

↑
flow bounded by capacity

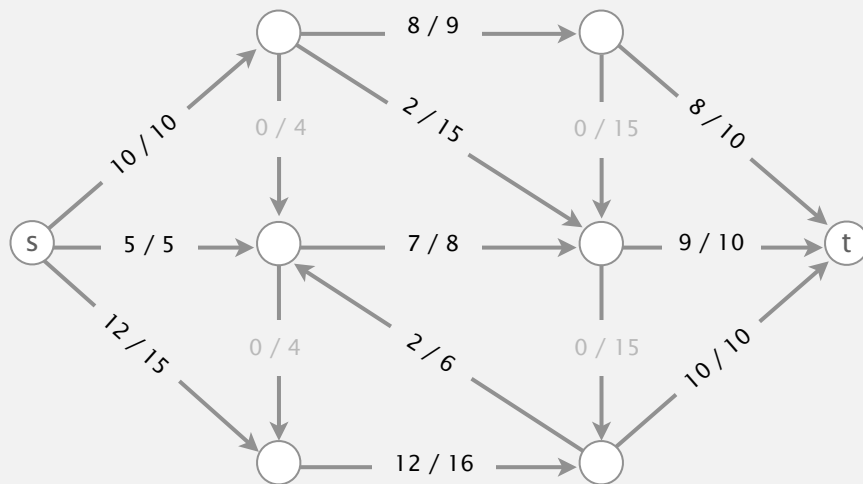

value of flow = 27

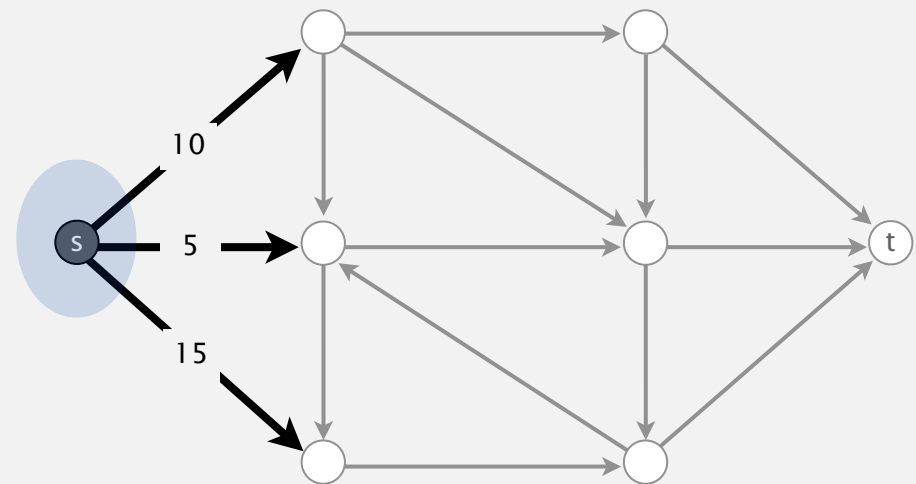

capacity of cut = 30

Maxflow-minicut theorem

Augmenting path theorem. A flow f is a maxflow iff no augmenting paths.

Maxflow-minicut theorem. Value of the maxflow = capacity of mincut.

Pf. The following three conditions are equivalent for any flow f :

- i. There exists a cut whose capacity equals the value of the flow f .
- ii. f is a maxflow.
- iii. There is no augmenting path with respect to f .

[i \Rightarrow ii]

- Suppose that (A, B) is a cut with capacity equal to the value of f .
- Then, the value of any flow $f' \leq$ capacity of $(A, B) =$ value of f .
- Thus, f is a maxflow.

↑
weak duality

Maxflow-minicut theorem

Augmenting path theorem. A flow f is a maxflow iff no augmenting paths.

Maxflow-minicut theorem. Value of the maxflow = capacity of mincut.

Pf. The following three conditions are equivalent for any flow f :

- i. There exists a cut whose capacity equals the value of the flow f .
- ii. f is a maxflow.
- iii. There is no augmenting path with respect to f .

[ii \Rightarrow iii] We prove contrapositive: \sim iii \Rightarrow \sim ii.

- Suppose that there is an augmenting path with respect to f .
- Can improve flow f by sending flow along this path.
- Thus, f is not a maxflow.

Maxflow-minicut theorem

Augmenting path theorem. A flow f is a maxflow iff no augmenting paths.

Maxflow-minicut theorem. Value of the maxflow = capacity of mincut.

Pf. The following three conditions are equivalent for any flow f :

- i. There exists a cut whose capacity equals the value of the flow f .
- ii. f is a maxflow.
- iii. There is no augmenting path with respect to f .

[iii \Rightarrow i]

Suppose that there is no augmenting path with respect to f .

- Let (A, B) be a cut where A is the set of vertices connected to s by an undirected path with no full forward or empty backward edges.
- By definition, s is in A ; since no augmenting path, t is in B .
- Capacity of cut = net flow across cut \longleftarrow forward edges full; backward edges empty
= value of flow f . \longleftarrow flow-value proposition

Computing a mincut from a maxflow

To compute mincut (A, B) from maxflow f :

- By augmenting path theorem, no augmenting paths with respect to f .
- Compute A = set of vertices connected to s by an undirected path with no full forward or empty backward edges.

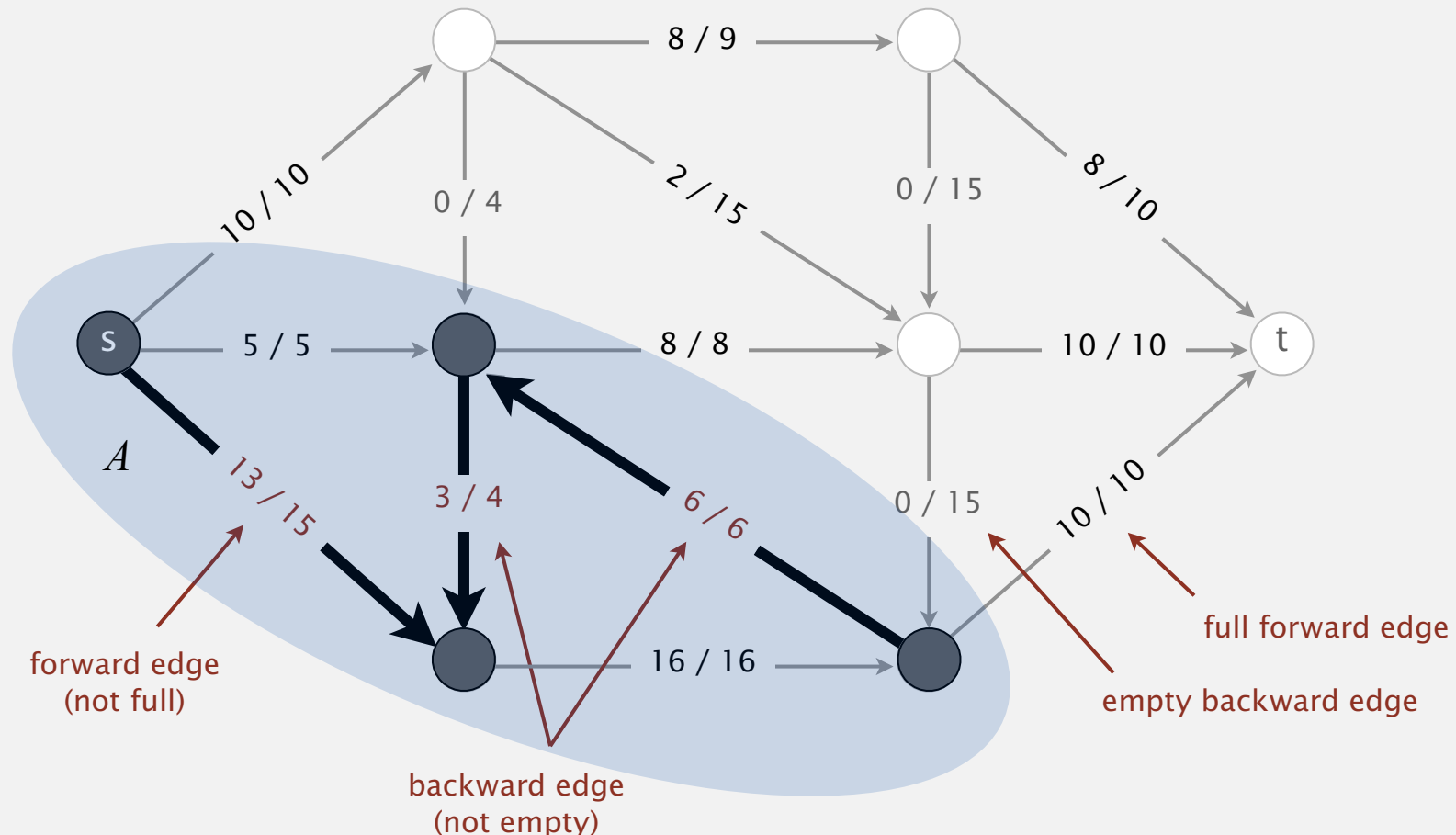

Ford-Fulkerson algorithm

Ford-Fulkerson algorithm

Start with 0 flow.

While there exists an augmenting path:

- find an augmenting path
 - compute bottleneck capacity
 - increase flow on that path by bottleneck capacity
-

Questions.

- How to compute a mincut? *Easy. ✓*
- How to find an augmenting path? *BFS works well.*
- If FF terminates, does it always compute a maxflow? *Yes. ✓*
- Does FF always terminate? If so, after how many augmentations?

yes, provided edge capacities are integers
(or augmenting paths are chosen carefully)

requires clever analysis
(see COS 423)

Ford-Fulkerson algorithm with integer capacities

Important special case. Edge capacities are integers between 1 and U .

Invariant. The flow is **integer-valued** throughout FF.
 flow on each edge is an integer

Pf. [by induction]

- Bottleneck capacity is an integer.
- Flow on an edge increases/decreases by bottleneck capacity.

Proposition. Number of augmentations \leq the value of the maxflow.

Pf. Each augmentation increases the value by at least 1.

Integrality theorem. There exists an integer-valued maxflow.
 important for some applications (stay tuned)
 and FF finds one!

Pf. FF terminates; invariant ensures maxflow that FF finds is integer-valued.

Bad case for Ford-Fulkerson

Bad news. Even when edge capacities are integers, number of augmenting paths could be equal to the value of the maxflow.

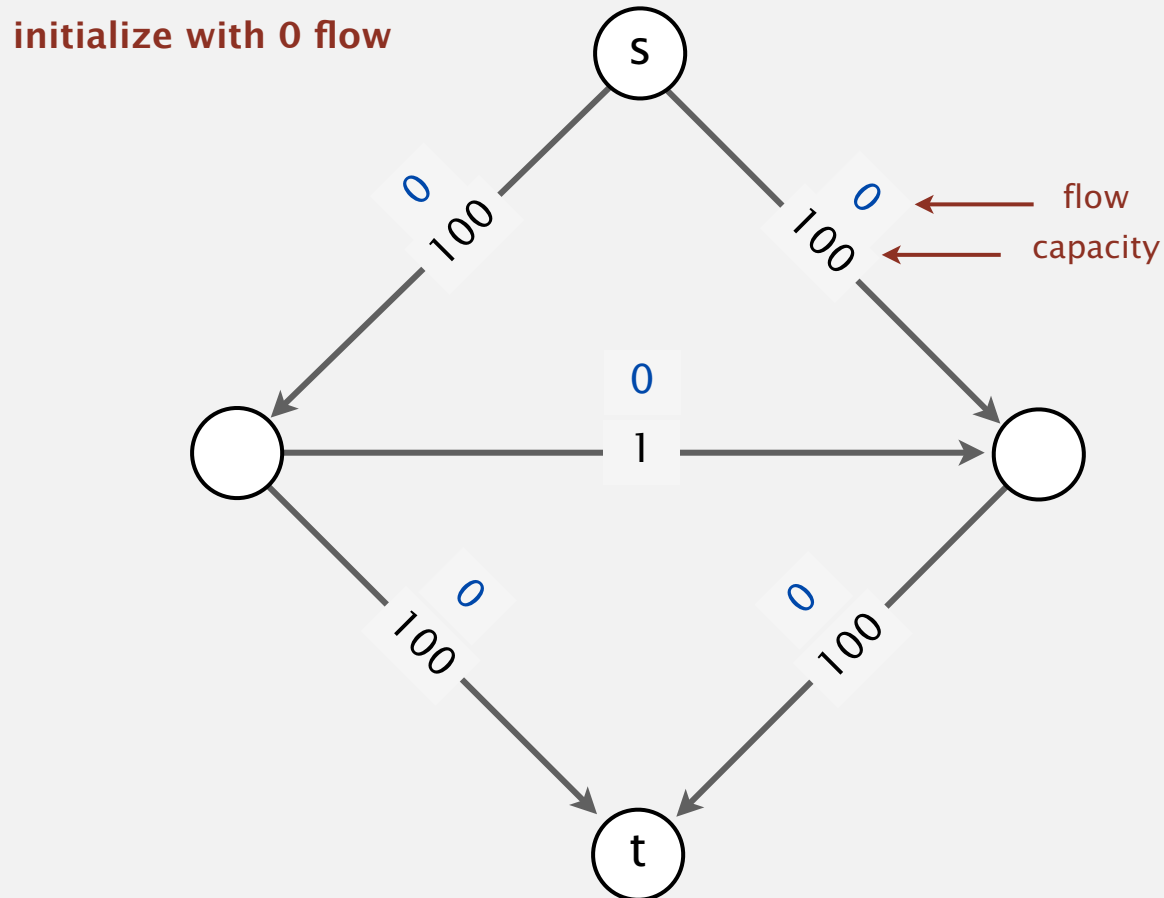

Bad case for Ford-Fulkerson

Bad news. Even when edge capacities are integers, number of augmenting paths could be equal to the value of the maxflow.

1st iteration

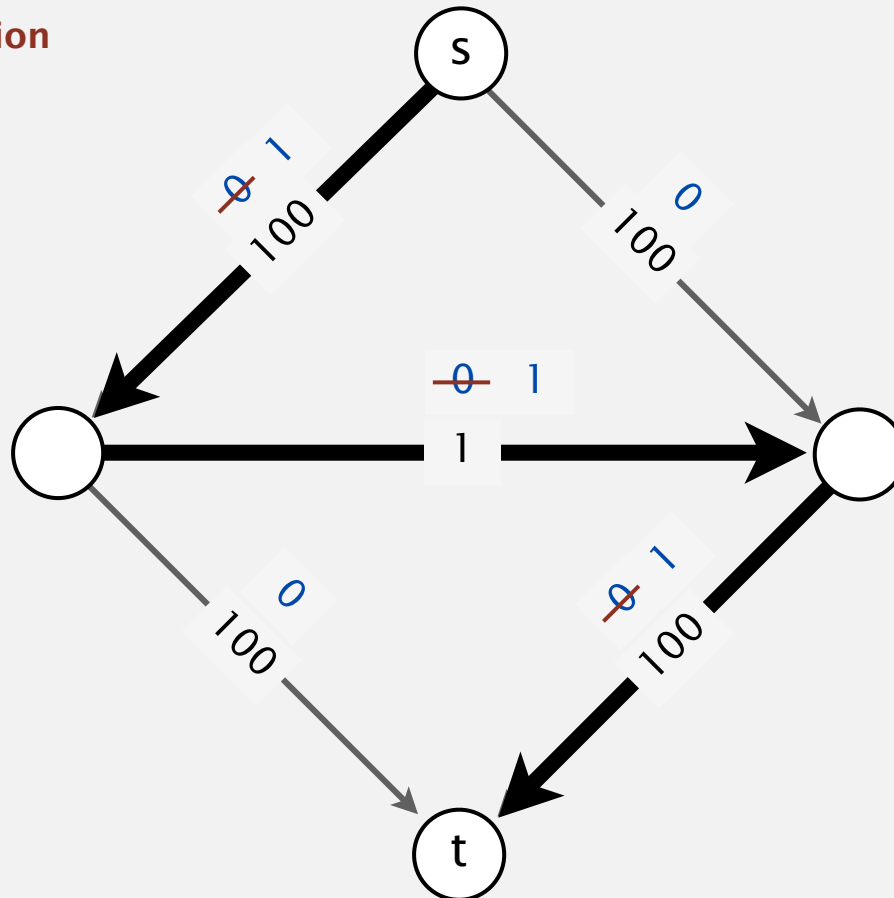

Bad case for Ford-Fulkerson

Bad news. Even when edge capacities are integers, number of augmenting paths could be equal to the value of the maxflow.

2nd iteration

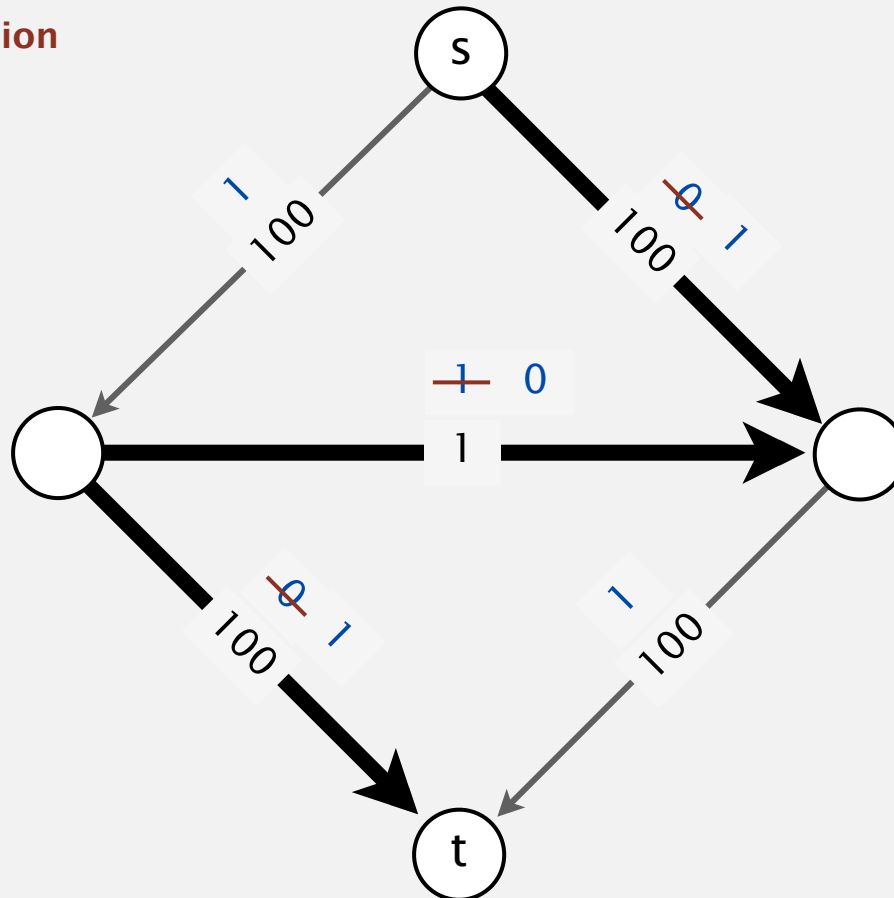

Bad case for Ford-Fulkerson

Bad news. Even when edge capacities are integers, number of augmenting paths could be equal to the value of the maxflow.

3rd iteration

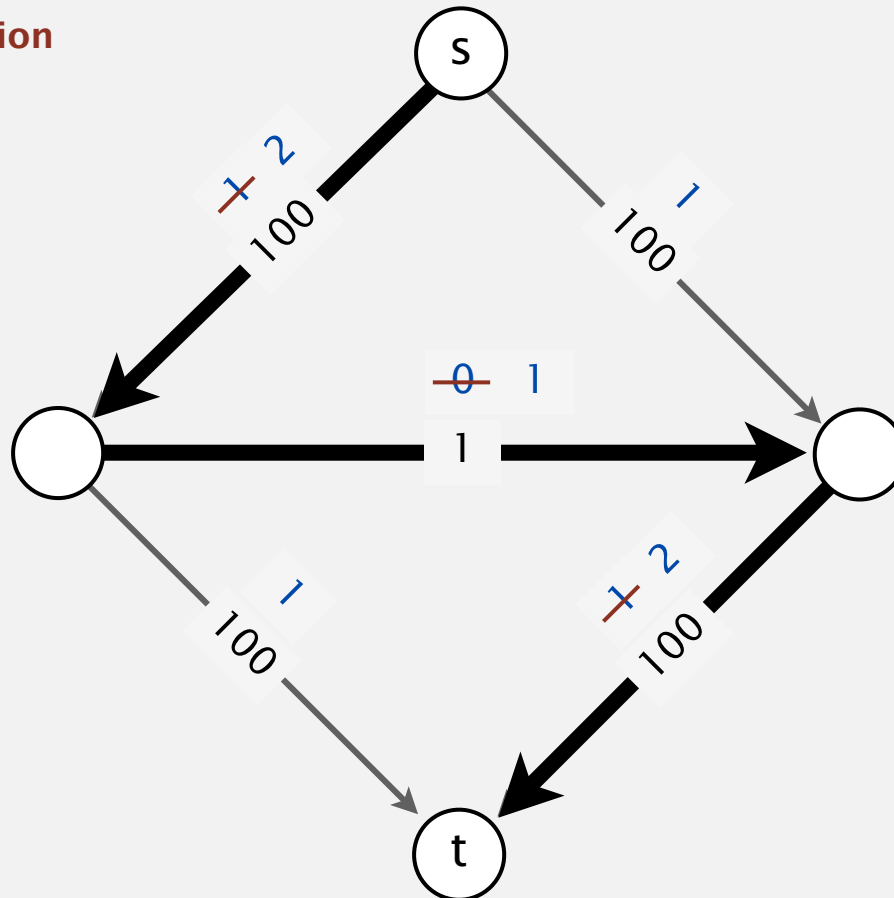

Bad case for Ford-Fulkerson

Bad news. Even when edge capacities are integers, number of augmenting paths could be equal to the value of the maxflow.

4th iteration

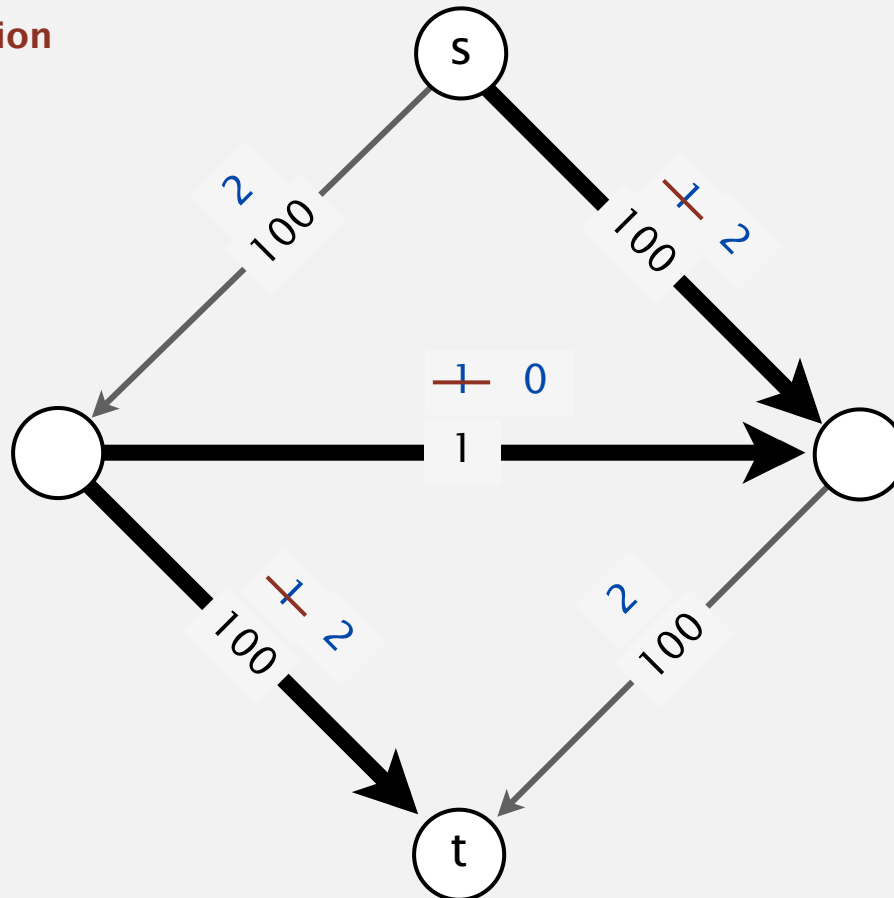

Bad case for Ford-Fulkerson

Bad news. Even when edge capacities are integers, number of augmenting paths could be equal to the value of the maxflow.



Bad case for Ford-Fulkerson

Bad news. Even when edge capacities are integers, number of augmenting paths could be equal to the value of the maxflow.

199th iteration

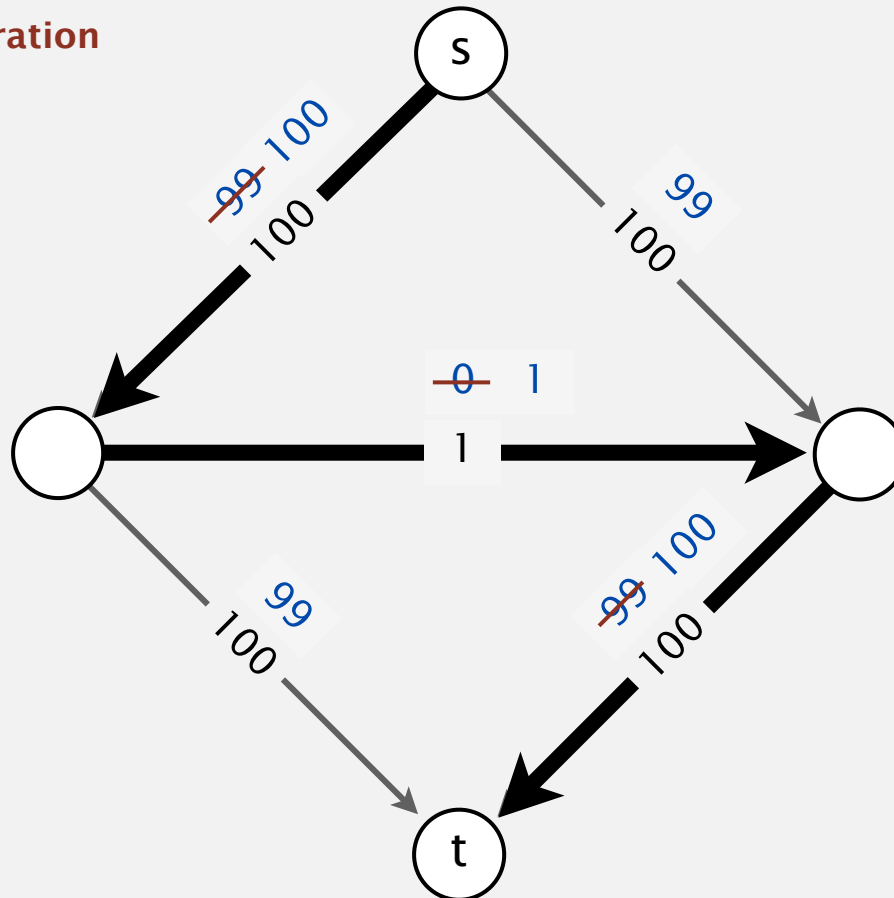

Bad case for Ford-Fulkerson

Bad news. Even when edge capacities are integers, number of augmenting paths could be equal to the value of the maxflow.

200th iteration

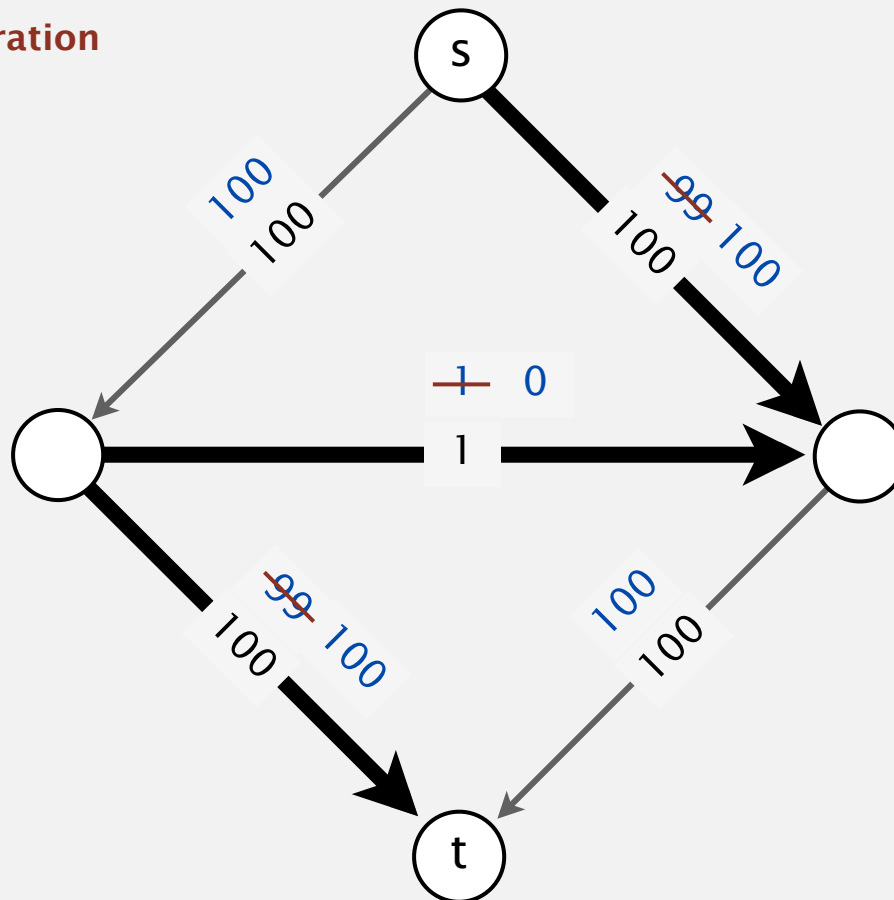

Bad case for Ford-Fulkerson

Bad news. Even when edge capacities are integers, number of augmenting paths could be equal to the value of the maxflow.

← can be exponential in input size

Good news. This case is easily avoided. [use shortest/fattest augmenting path]

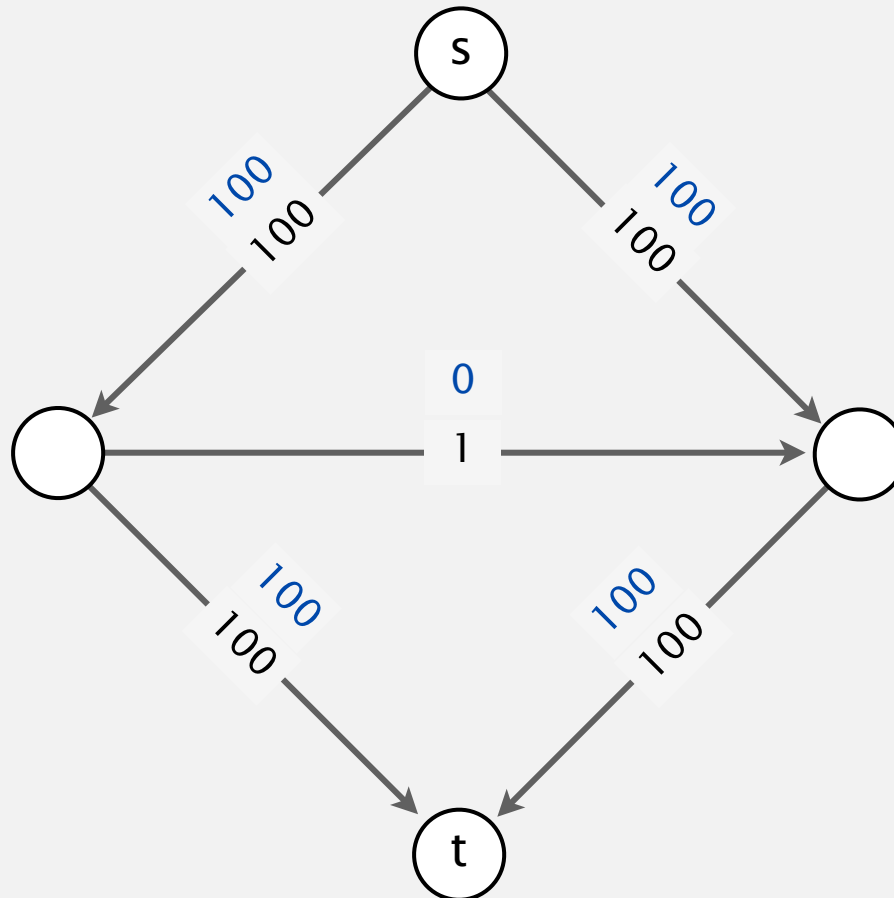

How to choose augmenting paths?

FF performance depends on choice of augmenting paths.

augmenting path	number of paths	implementation
shortest path	$\leq \frac{1}{2} E V$	queue (BFS)
fattest path	$\leq E \ln(E U)$	priority queue
random path	$\leq E U$	randomized queue
DFS path	$\leq E U$	stack (DFS)

digraph with V vertices, E edges, and integer capacities (max U)

augmenting path
with fewest
number of edges

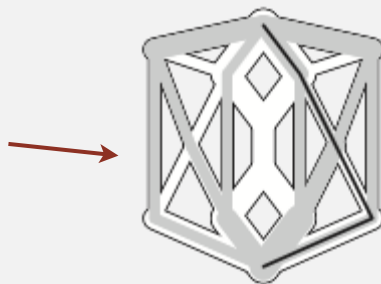

shortest path

augmenting path
with maximum
bottleneck capacity

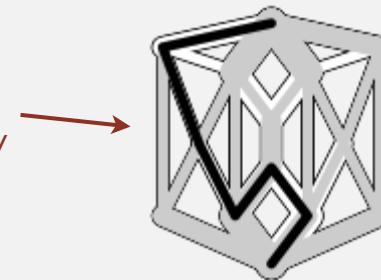

fattest path

- ▶ overview
- ▶ Ford-Fulkerson algorithm
- ▶ analysis
- ▶ **Java implementation**
- ▶ applications

Flow network representation

Flow edge data type. Associate flow f_e and capacity c_e with edge $e = v \rightarrow w$.

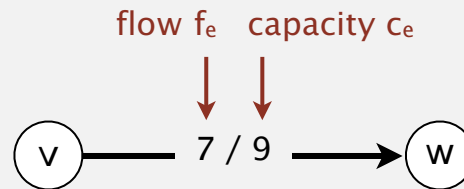

Flow network data type. Need to process edge $e = v \rightarrow w$ in either direction:
Include e in both v and w 's adjacency lists.

Residual capacity.

- Forward edge: residual capacity $= c_e - f_e$.
- Backward edge: residual capacity $= f_e$.

Augment flow.

- Forward edge: add Δ .
- Backward edge: subtract Δ .

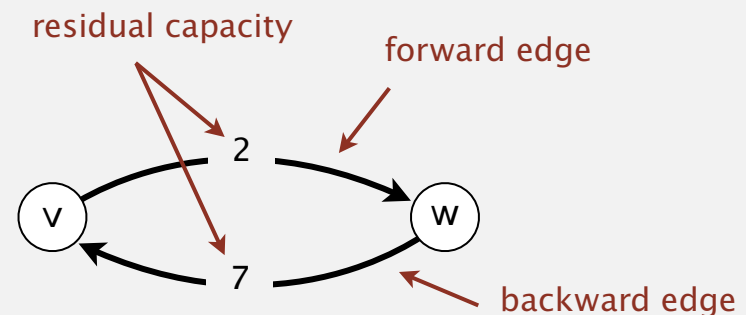

Flow network representation

Residual network. A useful view of a flow network.

original network

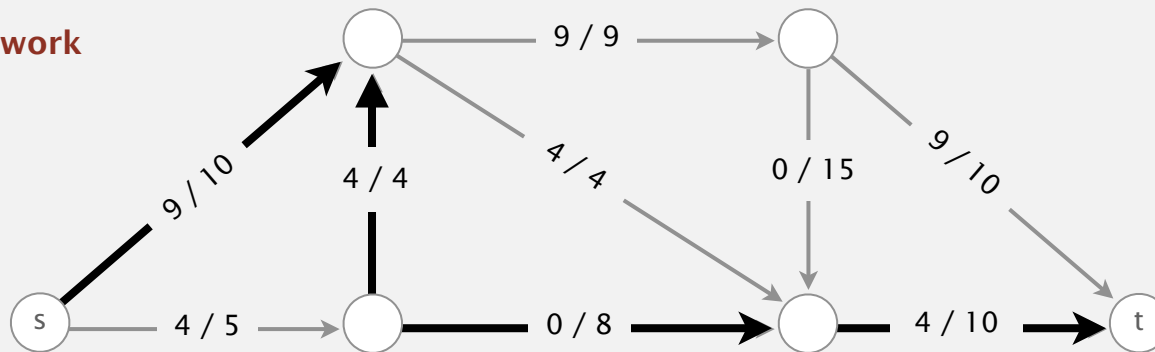

residual network

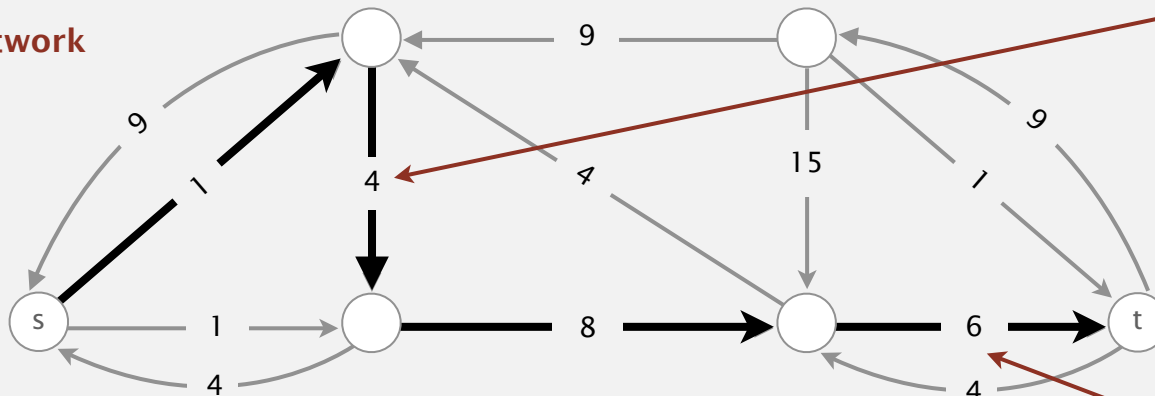

backward edge
(not empty)

forward edge
(not full)

Key point. Augmenting path in original network is equivalent to directed path in residual network.

Flow edge API

```
public class FlowEdge
```

```
    FlowEdge(int v, int w, double capacity)    create a flow edge  $v \rightarrow w$  with given capacity  
  
    int from()                                vertex this edge points from  
  
    int to()                                  vertex this edge points to  
  
    int other(int v)                          other endpoint  
  
    double capacity()                         capacity of this edge  
  
    double flow()                             flow in this edge  
  
    double residualCapacityTo(int v)         residual capacity toward v  
  
    void addResidualFlowTo(int v, double delta) add delta flow toward v  
  
    String toString()                         string representation
```

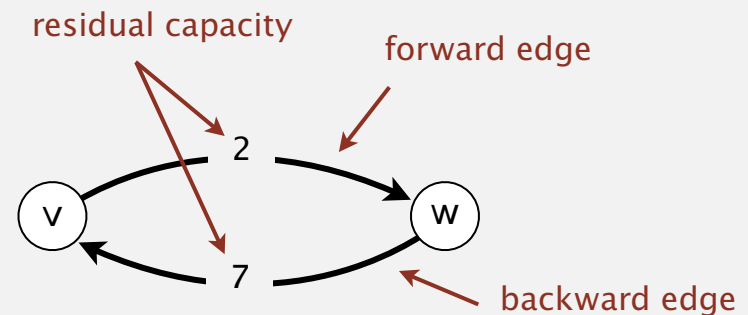
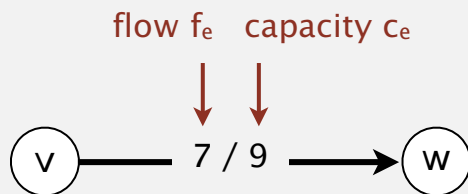

Flow edge: Java implementation

```
public class FlowEdge
{
    private final int v, w;           // from and to
    private final double capacity;    // capacity
    private double flow;              // flow

    public FlowEdge(int v, int w, double capacity)
    {
        this.v      = v;
        this.w      = w;
        this.capacity = capacity;
    }

    public int from()      { return v;      }
    public int to()        { return w;      }
    public double capacity() { return capacity; }
    public double flow()   { return flow;   }

    public int other(int vertex)
    {
        if (vertex == v) return w;
        else if (vertex == w) return v;
        else throw new RuntimeException("Illegal endpoint");
    }

    public double residualCapacityTo(int vertex) {...}
    public void addResidualFlowTo(int vertex, double delta) {...}
}
```

← flow variable

← next slide

Flow edge: Java implementation

```
public double residualCapacityTo(int vertex)
{
    if (vertex == v) return flow;
    else if (vertex == w) return capacity - flow;
    else throw new RuntimeException("Illegal endpoint");
}
```

← forward edge
← backward edge

```
public void addResidualFlowTo(int vertex, double delta)
{
    if (vertex == v) flow -= delta;
    else if (vertex == w) flow += delta;
    else throw new RuntimeException("Illegal endpoint");
}
```

← forward edge
← backward edge

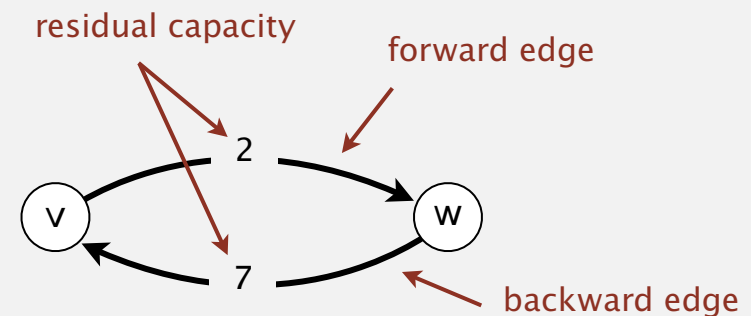
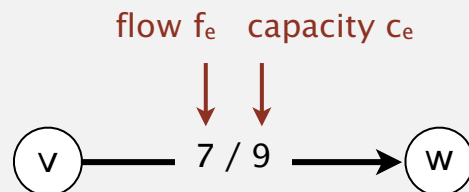

Flow network API

```
public class FlowNetwork
```

```
    FlowNetwork(int V)
```

create an empty flow network with V vertices

```
    FlowNetwork(In in)
```

construct flow network input stream

```
    void addEdge(FlowEdge e)
```

add flow edge e to this flow network

```
    Iterable<FlowEdge> adj(int v)
```

forward and backward edges incident to v

```
    Iterable<FlowEdge> edges()
```

all edges in this flow network

```
    int V()
```

number of vertices

```
    int E()
```

number of edges

```
    String toString()
```

string representation

Conventions. Allow self-loops and parallel edges.

Flow network: Java implementation

```
public class FlowNetwork
{
    private final int V;
    private Bag<FlowEdge>[] adj;

    public FlowNetwork(int V)
    {
        this.V = V;
        adj = (Bag<FlowEdge>[]) new Bag[V];
        for (int v = 0; v < V; v++)
            adj[v] = new Bag<FlowEdge>();
    }

    public void addEdge(FlowEdge e)
    {
        int v = e.from();
        int w = e.to();
        adj[v].add(e);
        adj[w].add(e);
    }

    public Iterable<FlowEdge> adj(int v)
    { return adj[v]; }
}
```

← same as `EdgeWeightedGraph`,
but adjacency lists of
`FlowEdges` instead of `Edges`

← add forward edge
← add backward edge

Flow network: adjacency-lists representation

Maintain vertex-indexed array of `FlowEdge` lists (use `Bag` abstraction).

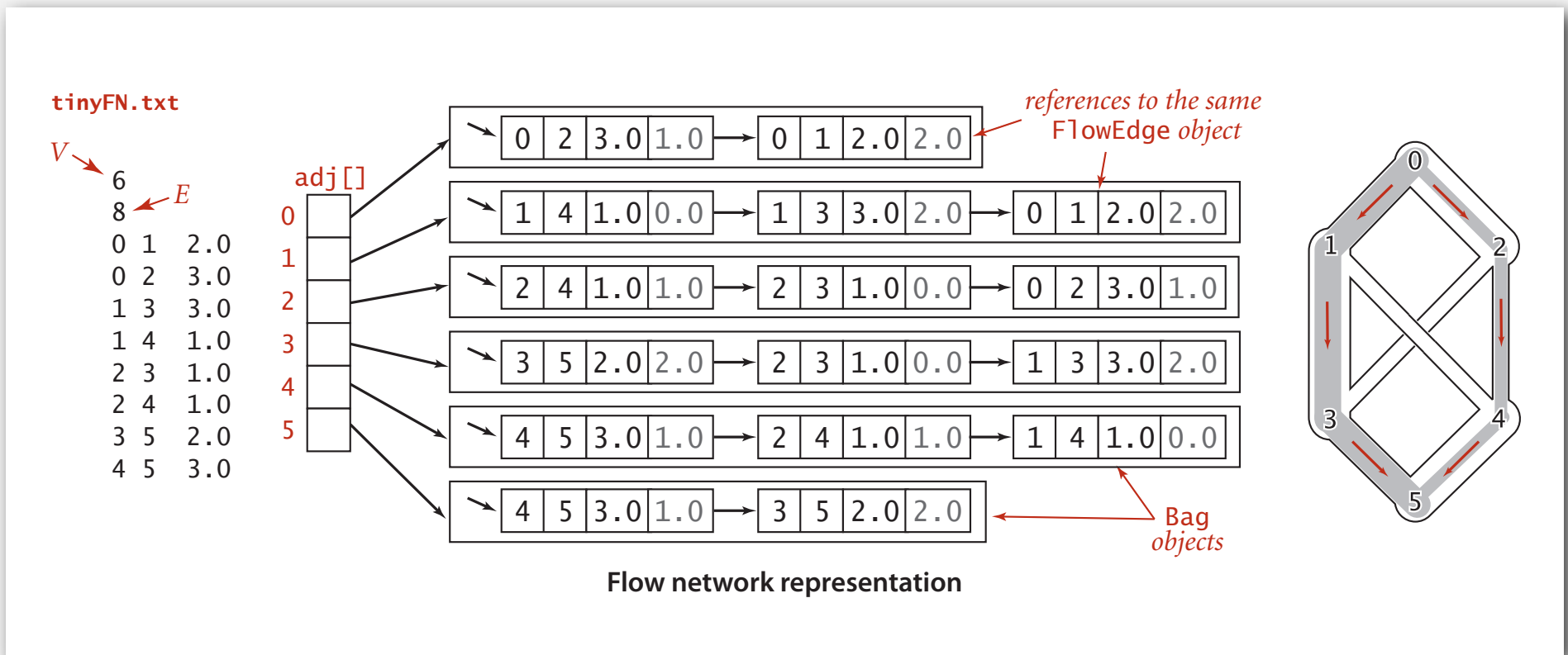

Ford-Fulkerson: Java implementation

```
public class FordFulkerson
{
    private boolean[] marked;    // true if s->v path in residual network
    private FlowEdge[] edgeTo;  // last edge on s->v path
    private double value;       // value of flow

    public FordFulkerson(FlowNetwork G, int s, int t)
    {
        value = 0;
        while (hasAugmentingPath(G, s, t))
        {
            double bottle = Double.POSITIVE_INFINITY;
            for (int v = t; v != s; v = edgeTo[v].other(v))
                bottle = Math.min(bottle, edgeTo[v].residualCapacityTo(v));
            for (int v = t; v != s; v = edgeTo[v].other(v))
                edgeTo[v].addResidualFlowTo(v, bottle);
            value += bottle;
        }
    }

    public double hasAugmentingPath(FlowNetwork G, int s, int t)
    { /* See next slide. */ }

    public double value()
    { return value; }

    public boolean inCut(int v)
    { return marked[v]; }
}
```

compute bottleneck capacity

augment flow

is v reachable from s in residual network?

Finding a shortest augmenting path (cf. breadth-first search)

```
private boolean hasAugmentingPath(FlowNetwork G, int s, int t)
{
    edgeTo = new FlowEdge[G.V()];
    marked = new boolean[G.V()];

    Queue<Integer> q = new Queue<Integer>();
    q.enqueue(s);
    marked[s] = true;
    while (!q.isEmpty())
    {
        int v = q.dequeue();

        for (FlowEdge e : G.adj(v))
        {
            int w = e.other(v);
            if (e.residualCapacityTo(w) > 0 && !marked[w])
            {
                edgeTo[w] = e;
                marked[w] = true;
                q.enqueue(w);
            }
        }
    }

    return marked[t];
}
```

found path from s to w
in the residual network?

save last edge on path to w;
mark w;
add w to the queue

is t reachable from s in residual network?

- ▶ overview
- ▶ Ford-Fulkerson algorithm
- ▶ analysis
- ▶ Java implementation
- ▶ **applications**

Maxflow and mincut applications

Maxflow/mincut is a widely applicable problem-solving model.

- Data mining.
- Open-pit mining.
- **Bipartite matching.**
- Network reliability.
- Image segmentation.
- Network connectivity.
- Distributed computing.
- Egalitarian stable matching.
- Security of statistical data.
- Multi-camera scene reconstruction.
- Sensor placement for homeland security.
- **Baseball elimination.** ← see next programming assignment
- Many, many, more.

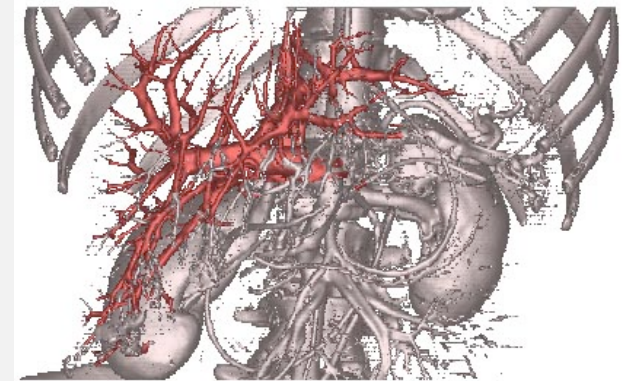

liver and hepatic vascularization segmentation

Bipartite matching problem

N students apply for N jobs.



Each gets several offers.



Is there a way to match all students to jobs?



bipartite matching problem

1	Alice	6	Adobe
	Adobe		Alice
	Amazon		Bob
	Google		Carol
2	Bob	7	Amazon
	Adobe		Alice
	Amazon		Bob
3	Carol		Dave
	Adobe		Eliza
	Facebook	8	Facebook
	Google		Carol
4	Dave	9	Google
	Amazon		Alice
	Yahoo		Carol
5	Eliza	10	Yahoo
	Amazon		Dave
	Yahoo		Eliza

Bipartite matching problem

Given a bipartite graph, find a maximal matching.

perfect matching (solution)

- Alice — Google
- Bob — Adobe
- Carol — Facebook
- Dave — Yahoo
- Eliza — Amazon

bipartite graph

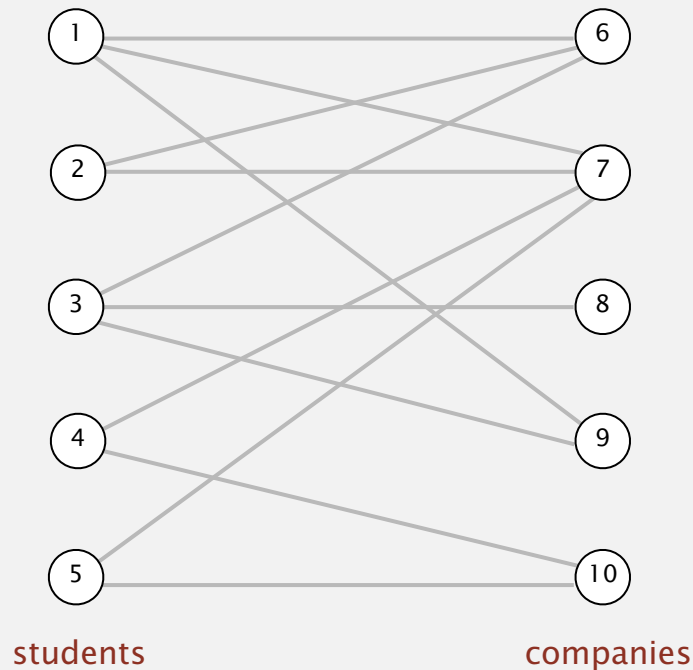

bipartite matching problem

- | | | | |
|---|----------|----|----------|
| 1 | Alice | 6 | Adobe |
| | Adobe | | Alice |
| | Amazon | | Bob |
| | Google | | Carol |
| 2 | Bob | 7 | Amazon |
| | Adobe | | Alice |
| | Amazon | | Bob |
| 3 | Carol | | Dave |
| | Adobe | | Eliza |
| | Facebook | 8 | Facebook |
| | Google | | Carol |
| 4 | Dave | 9 | Google |
| | Amazon | | Alice |
| | Yahoo | | Carol |
| 5 | Eliza | 10 | Yahoo |
| | Amazon | | Dave |
| | Yahoo | | Eliza |

Network flow formulation of bipartite matching

- Create s, t , one vertex for each student, and one vertex for each job.
- Add edge from s to each student (capacity 1).
- Add edge from each job to t (capacity 1).
- Add edge from student to each job offered (infinite capacity).

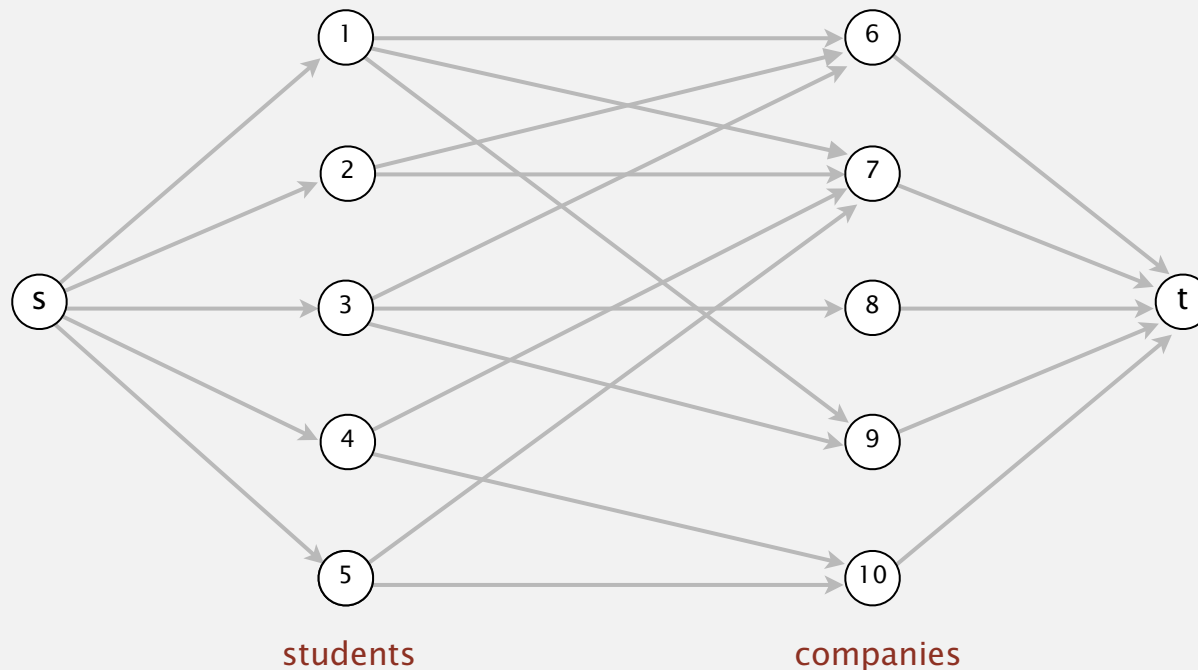

bipartite matching problem

1	Alice	6	Adobe
	Adobe		Alice
	Amazon		Bob
	Google		Carol
2	Bob	7	Amazon
	Adobe		Alice
	Amazon		Bob
3	Carol		Dave
	Adobe		Eliza
	Facebook	8	Facebook
	Google		Carol
4	Dave	9	Google
	Amazon		Alice
	Yahoo		Carol
5	Eliza	10	Yahoo
	Amazon		Dave
	Yahoo		Eliza

Network flow formulation of bipartite matching

1-1 correspondence between **integer-valued maxflow** solution of **value N** and perfect matchings.

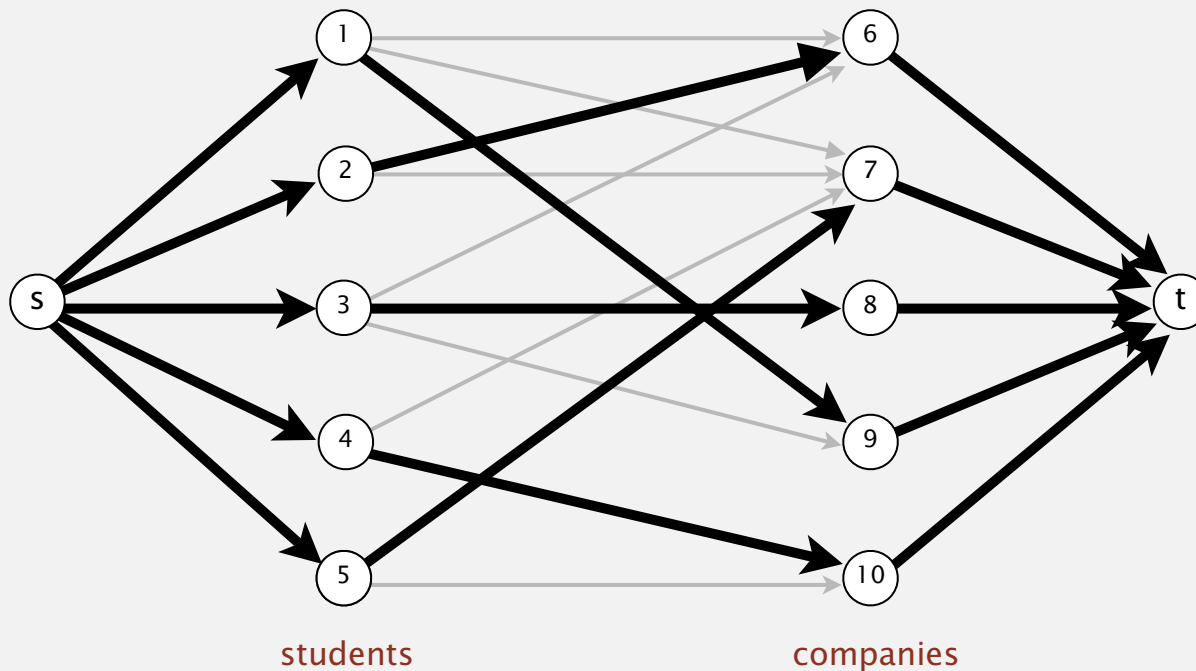

bipartite matching problem

1	Alice	6	Adobe
	Adobe		Alice
	Amazon		Bob
	Google		Carol
2	Bob	7	Amazon
	Adobe		Alice
	Amazon		Bob
3	Carol		Dave
	Adobe		Eliza
	Facebook	8	Facebook
	Google		Carol
4	Dave	9	Google
	Amazon		Alice
	Yahoo		Carol
5	Eliza	10	Yahoo
	Amazon		Dave
	Yahoo		Eliza

What the mincut tells us

Goal. When no perfect matching, explain why.

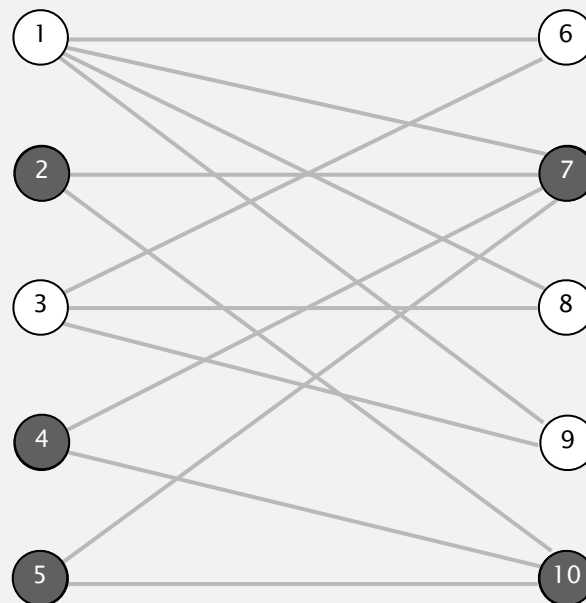

no perfect matching

$$S = \{ 2, 4, 5 \}$$
$$T = \{ 7, 10 \}$$

student in S
can be matched
only to
companies in T

$$|S| > T$$

What the mincut tells us

Mincut. Consider mincut (A, B) .

- Let S = students on s side of cut.
- Let T = companies on s side of cut.
- Fact: $|S| > |T|$ and students in S can only be matched to companies in T .

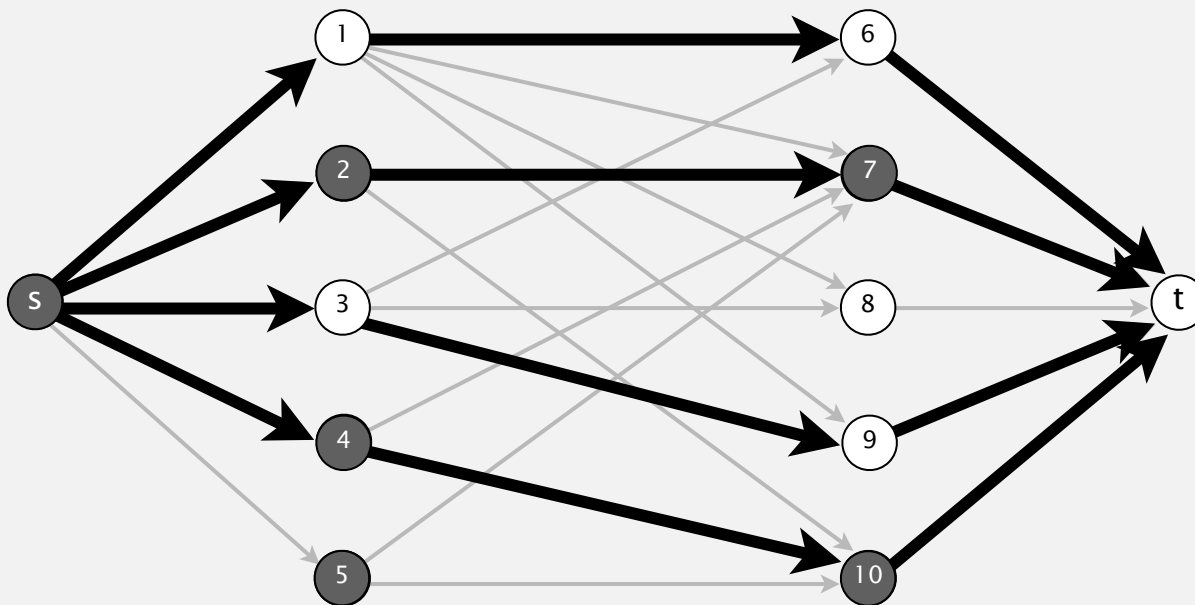

$S = \{ 2, 4, 5 \}$
 $T = \{ 7, 10 \}$

student in S
can be matched
only to
companies in T





$|S| > |T|$

no perfect matching

Bottom line. When no perfect matching, mincut explains why.

Baseball elimination

Q. Which teams have a chance of finishing the season with the most wins?



i	team	wins	losses	to play	ATL	PHI	NYM	MON	
0		Atlanta	83	71	8	–	1	6	1
1		Philly	80	79	3	1	–	0	2
2		New York	78	78	6	6	0	–	0
3		Montreal	77	82	3	1	2	0	–

Montreal is mathematically eliminated.

- Montreal finishes with ≤ 80 wins.
- Atlanta already has 83 wins.

Baseball elimination

Q. Which teams have a chance of finishing the season with the most wins?

i	team	wins	losses	to play	ATL	PHI	NYM	MON	
0		Atlanta	83	71	8	–	1	6	1
1		Philly	80	79	3	1	–	0	2
2		New York	78	78	6	6	0	–	0
3		Montreal	77	82	3	1	2	0	–





Philadelphia is mathematically eliminated.

- Philadelphia finishes with ≤ 83 wins.
- Either New York or Atlanta will finish with ≥ 84 wins.

Observation. Answer depends not only on how many games already won and left to play, but on **whom** they're against.

Baseball elimination

Q. Which teams have a chance of finishing the season with the most wins?

i	team	wins	losses	to play	NYN	BAL	BOS	TOR	DET
0	 New York	75	59	28	–	3	8	7	3
1	 Baltimore	71	63	28	3	–	2	7	4
2	 Boston	69	66	27	8	2	–	0	0
3	 Toronto	63	72	27	7	7	0	–	0
4	 Detroit	49	86	27	3	4	0	0	–

AL East (August 30, 1996)

Detroit is mathematically eliminated.

- Detroit finishes with ≤ 76 wins.
- Wins for $R = \{ \text{NYN, BAL, BOS, TOR} \} = 278$.
- Remaining games among $\{ \text{NYN, BAL, BOS, TOR} \} = 3 + 8 + 7 + 2 + 7 = 27$.
- Average team in R wins $305/4 = 76.25$ games.

Baseball elimination: maxflow formulation

Intuition. Remaining games flow from s to t .

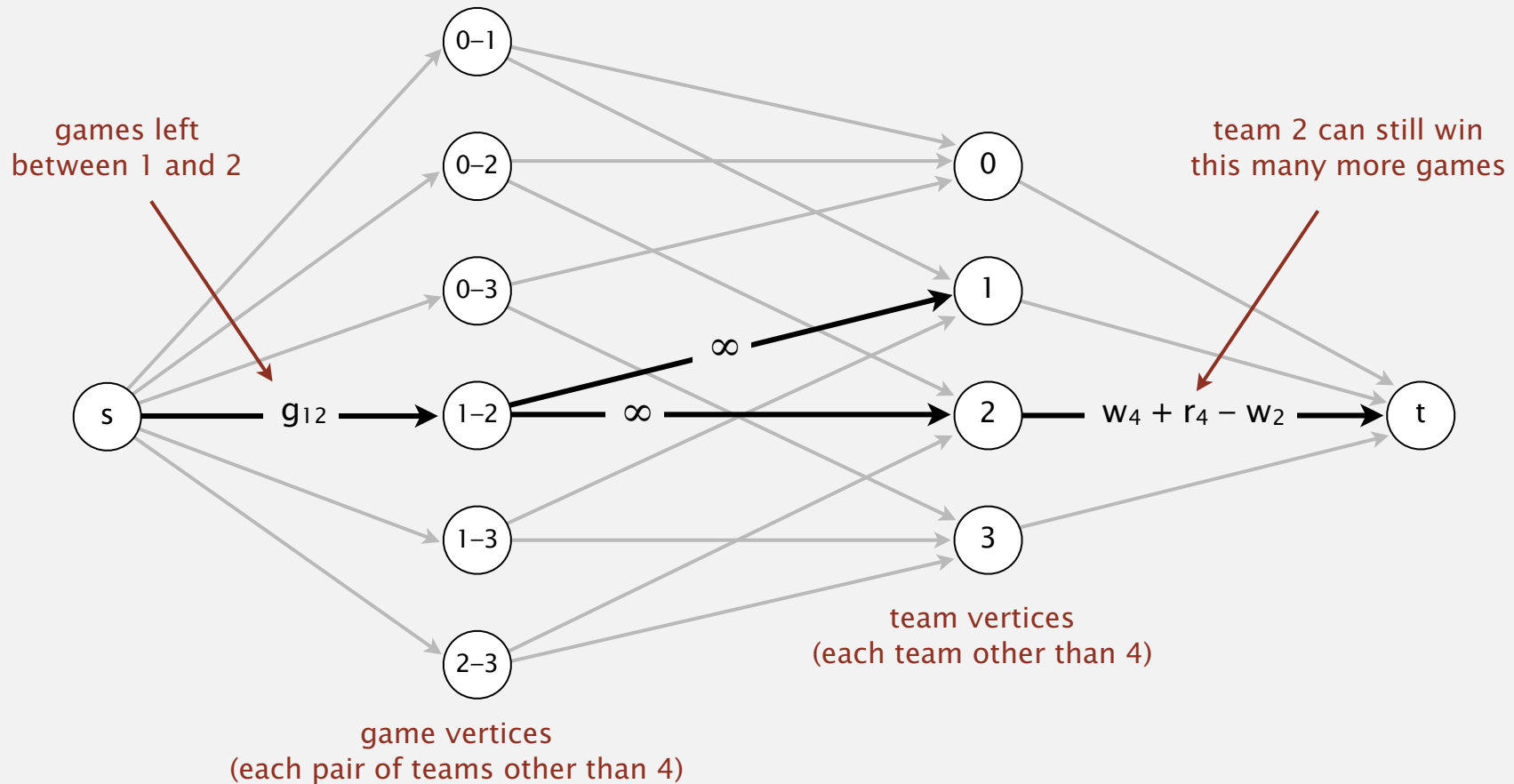

Fact. Team 4 not eliminated iff all edges pointing from s are full in maxflow.

Maximum flow algorithms: theory

(Yet another) holy grail for theoretical computer scientists.

year	method	worst case order of growth	discovered by
1951	simplex	$E^3 U$	Dantzig
1955	augmenting path	$E^2 U$	Ford-Fulkerson
1970	shortest augmenting path	E^3	Dinitz, Edmonds-Karp
1972	fattest augmenting path	$E^2 \log E \log(E U)$	Dinitz, Edmonds-Karp
1983	dynamic trees	$E^2 \log E$	Sleator-Tarjan
1985	capacity scaling	$E^2 \log U$	Gabow
1997	length function	$E^{3/2} \log E \log U$	Goldberg-Rao
?	?	E	?

maxflow algorithms for sparse digraphs with E edges, integer capacities (max U)

Maximum flow algorithms: practice

Warning. Worst-case order-of-growth is generally not useful for predicting or comparing maxflow algorithm performance in practice.

Best in practice. Push-relabel method with gap relabeling: $E^{3/2}$.

On Implementing Push-Relabel Method for the Maximum Flow Problem

Boris V. Cherkassky¹ and Andrew V. Goldberg²

¹ Central Institute for Economics and Mathematics,
Krasikova St. 32, 117418, Moscow, Russia
cher@cemi.msk.su

² Computer Science Department, Stanford University
Stanford, CA 94305, USA
goldberg@cs.stanford.edu

Abstract. We study efficient implementations of the push-relabel method for the maximum flow problem. The resulting codes are faster than the previous codes, and much faster on some problem families. The speedup is due to the combination of heuristics used in our implementations. We also exhibit a family of problems for which the running time of all known methods seem to have a roughly quadratic growth rate.



ELSEVIER

European Journal of Operational Research 97 (1997) 509–542

EUROPEAN
JOURNAL
OF OPERATIONAL
RESEARCH

Theory and Methodology

Computational investigations of maximum flow algorithms

Ravindra K. Ahuja^a, Murali Kodialam^b, Ajay K. Mishra^c, James B. Orlin^{d,*}

^a Department of Industrial and Management Engineering, Indian Institute of Technology, Kanpur, 208 016, India

^b AT & T Bell Laboratories, Holmdel, NJ 07733, USA

^c KATZ Graduate School of Business, University of Pittsburgh, Pittsburgh, PA 15260, USA

^d Sloan School of Management, Massachusetts Institute of Technology, Cambridge, MA 02139, USA

Received 30 August 1995; accepted 27 June 1996

Summary

Mincut problem. Find an st -cut of minimum capacity.

Maxflow problem. Find an st -flow of maximum value.

Duality. Value of the maxflow = capacity of mincut.

Proven successful approaches.

- Ford-Fulkerson (various augmenting-path strategies).
- Preflow-push (various versions).

Open research challenges.

- Practice: solve real-world maxflow/mincut problems in linear time.
- Theory: prove it for worst-case inputs.
- Still much to be learned!